

建築學會第一回講習會用

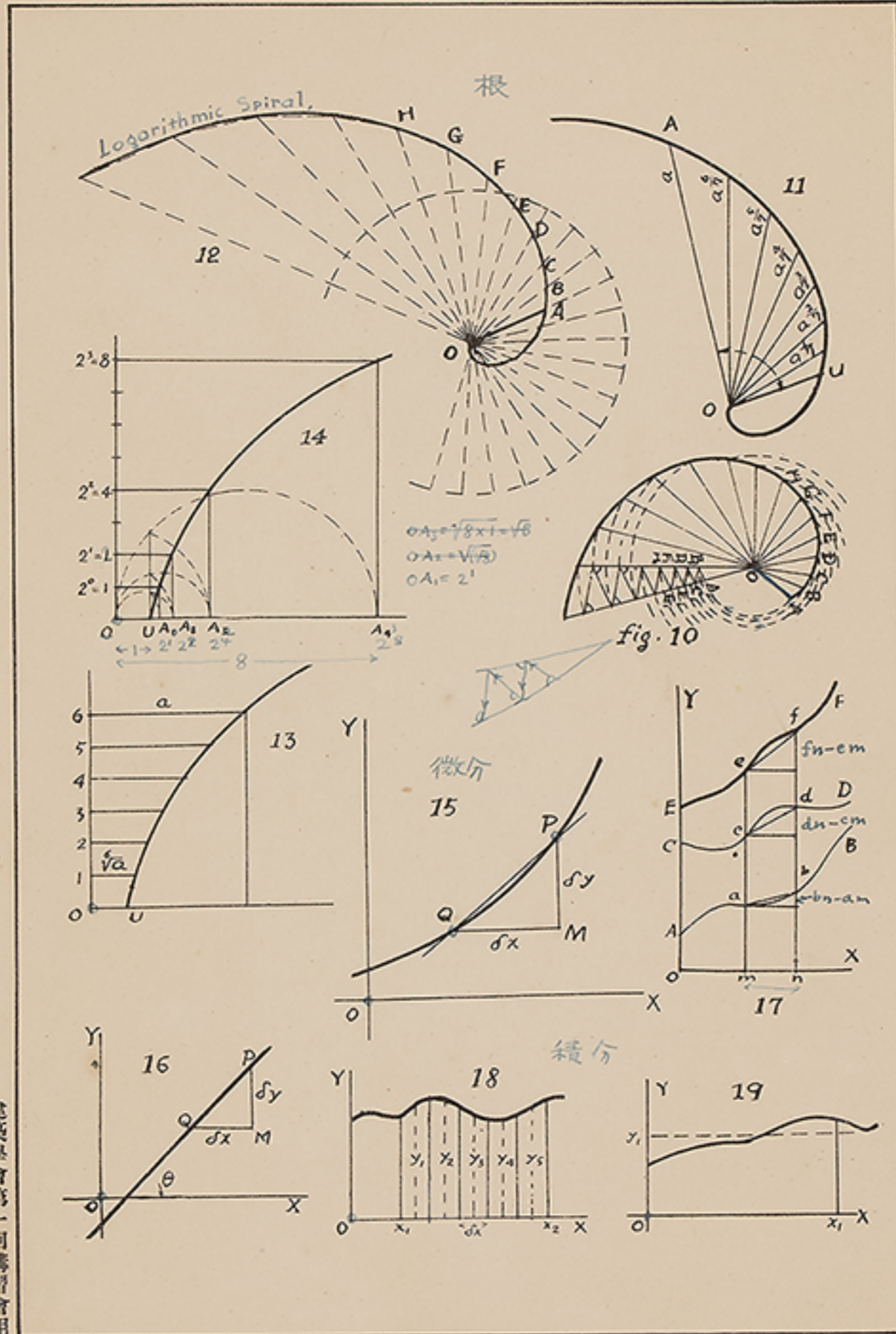

建築學會第一回講習會用

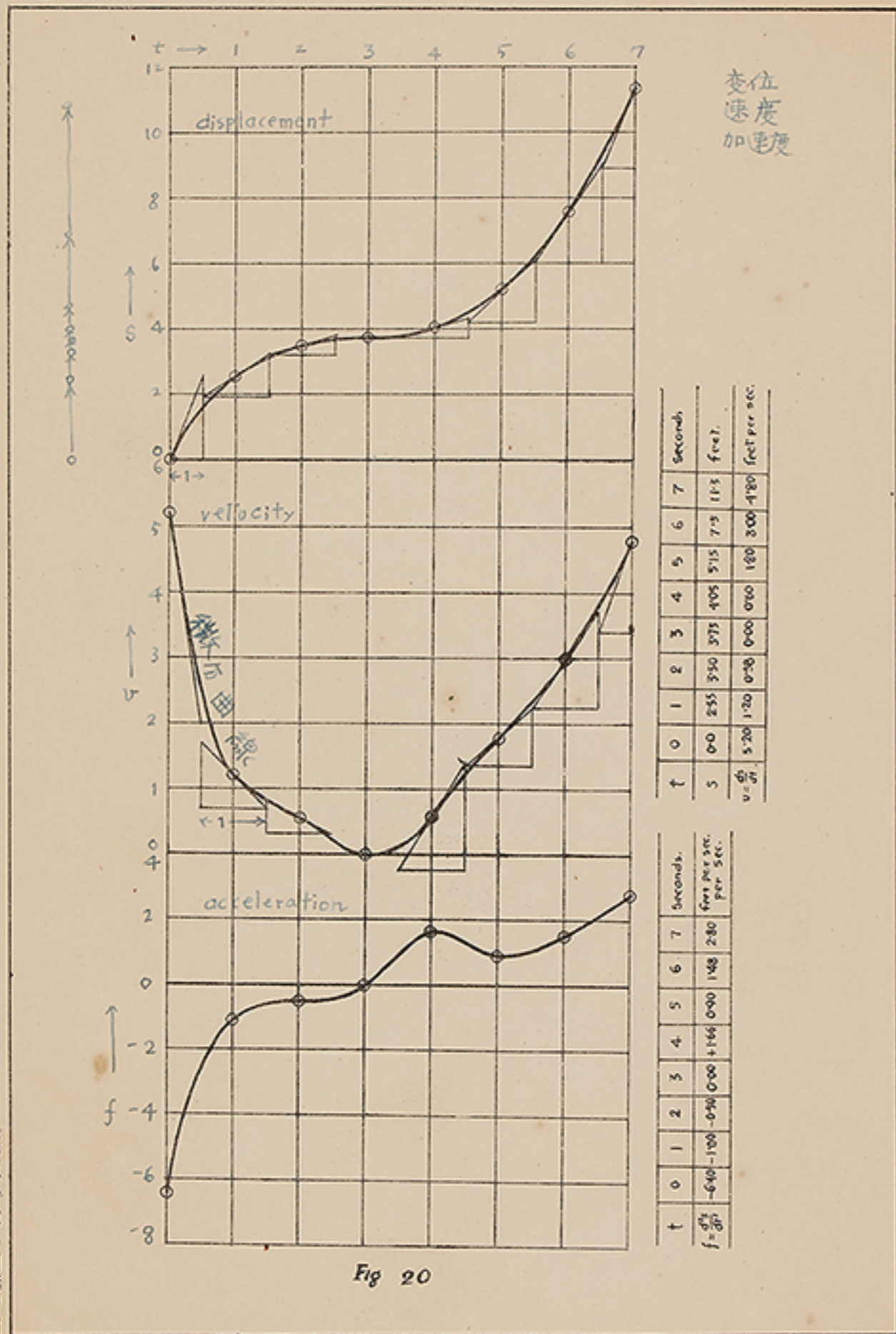
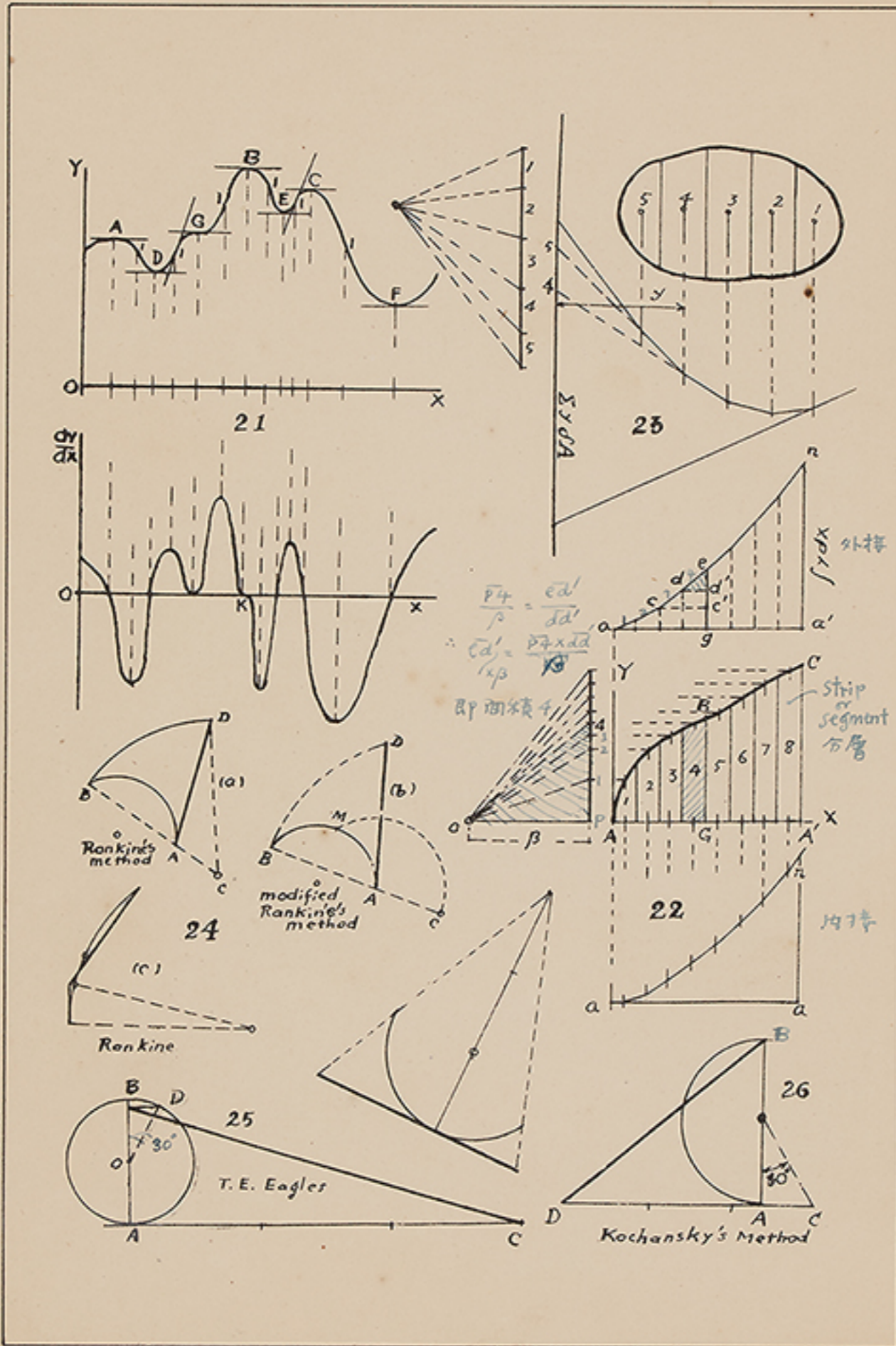
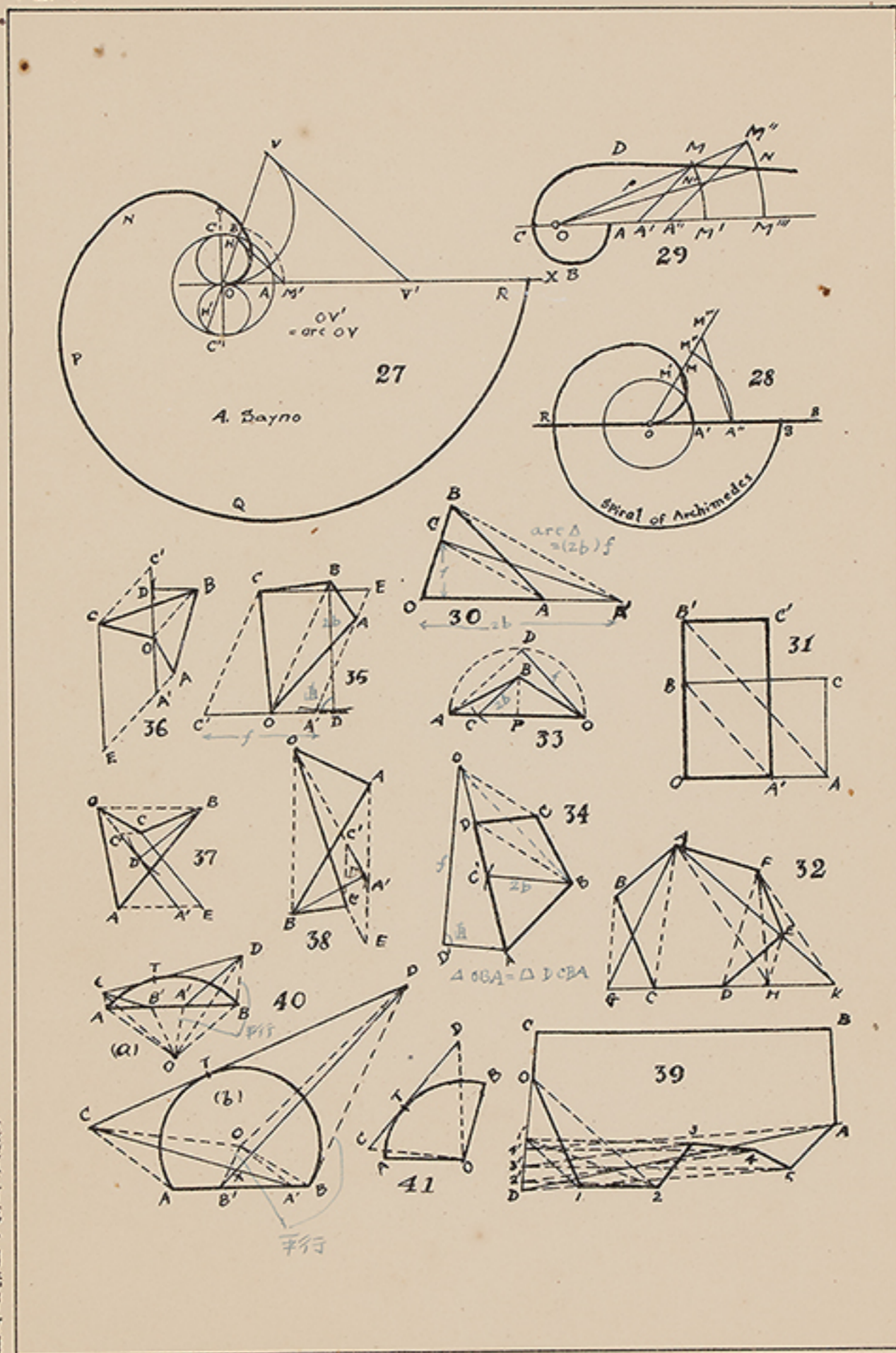

Fig 20

建築學會第二回講習用



建築學會第一回講習會用



建築學會第一回講習會用

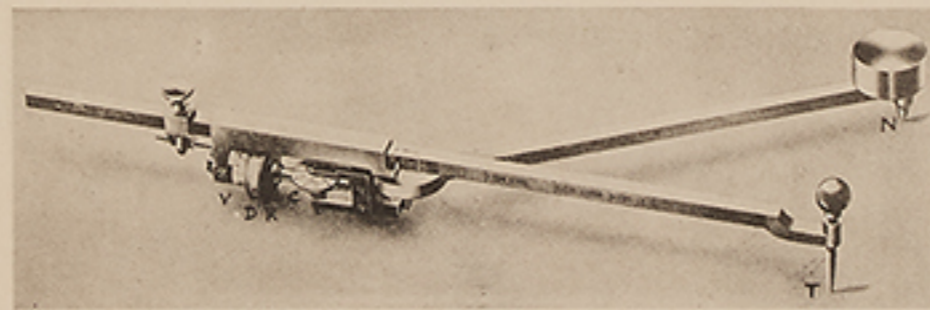
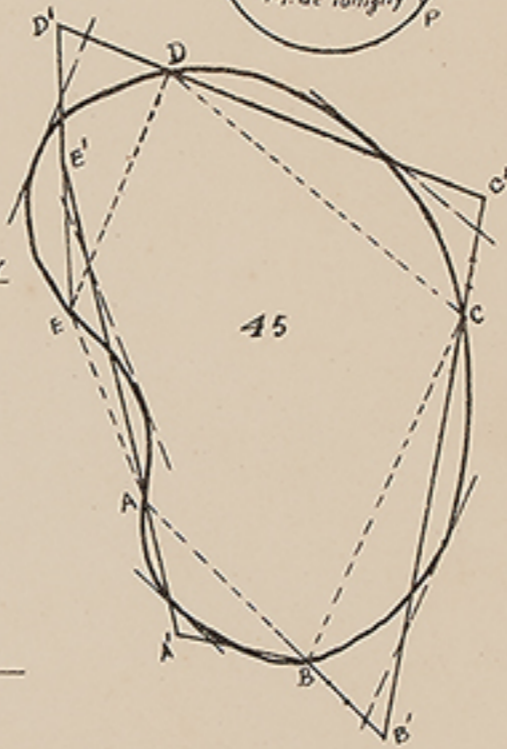
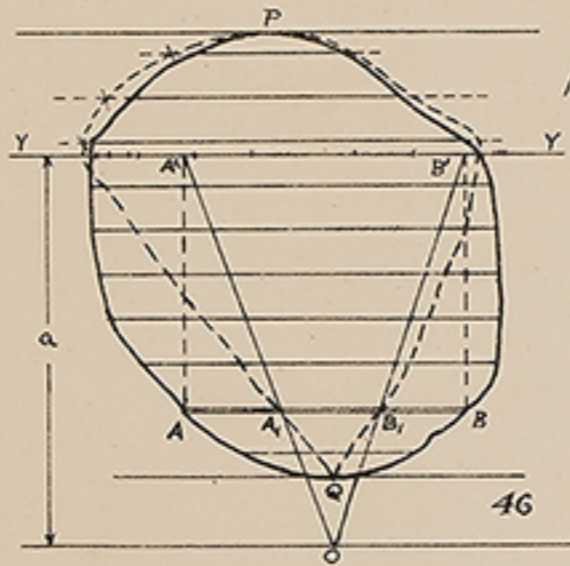
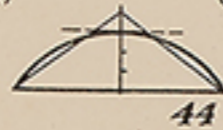
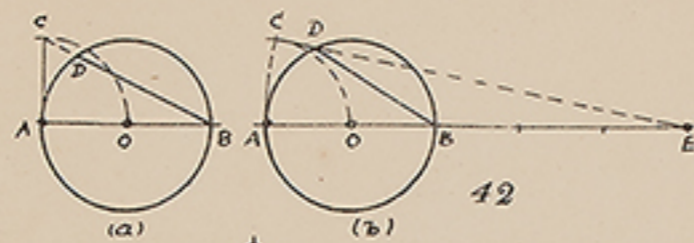

47. V-Vernier, R-Roller, D-Drum, C-Counting-disc, T-Tracing pt. N-Needle pt.

建築學會第一回講習會用

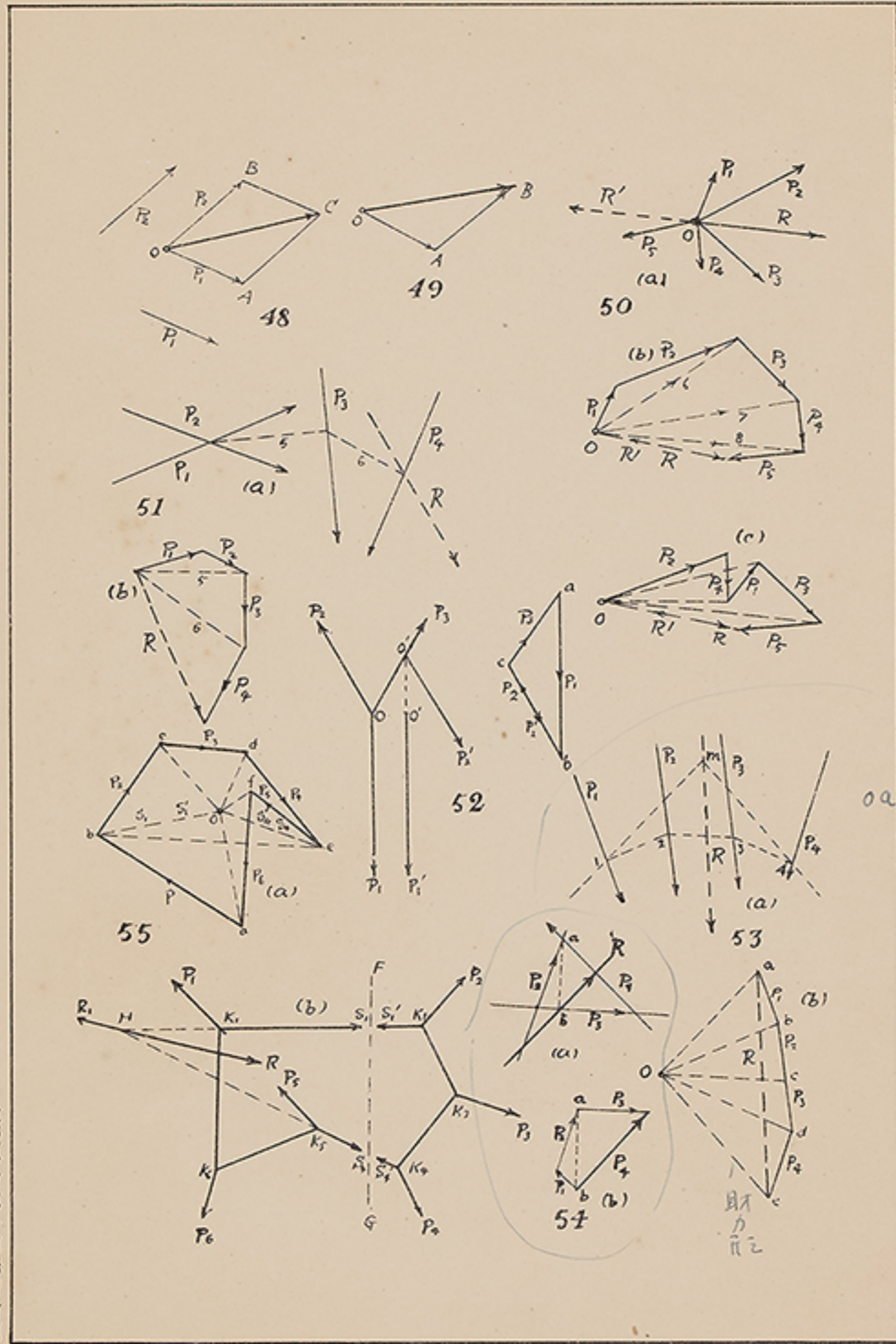

$oa + ob + P_1 = 0$

建築學會第一回講習會用

P_1, P_2 Couple.
 限力臂 arm

平行力の平衡

(a) P_1, P_2, P_3 の平衡
 $P_1 = P_2 + P_3$
 $P_1 \times BC = P_2 \times AC + P_3 \times AB$
 $\therefore P_1 = \frac{P_2 \times AC + P_3 \times AB}{BC}$

力の等距離にて全力の力

draw $bEh \parallel AMK$
 $Cc : Dd :: EC : Ed$

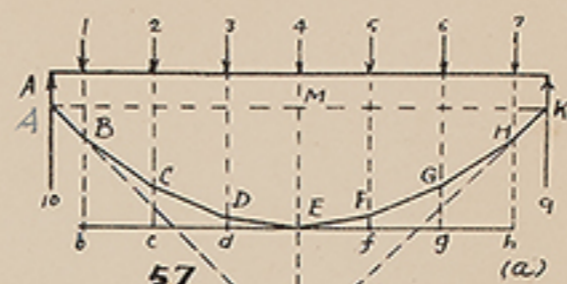
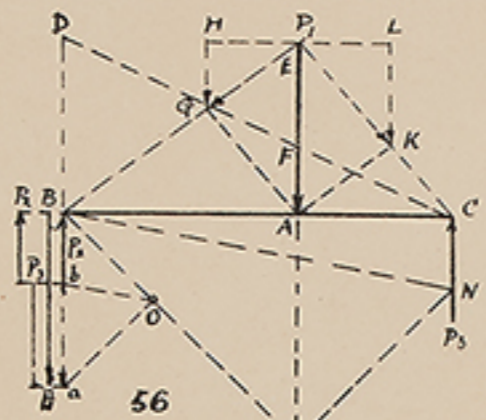

力の等距離にて全力の力

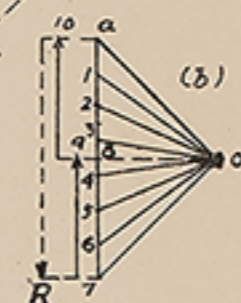
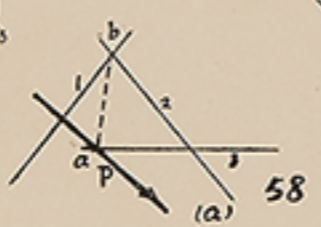
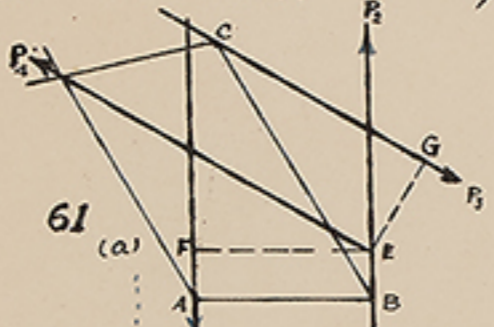

平行力の中心 (重心, 力心)

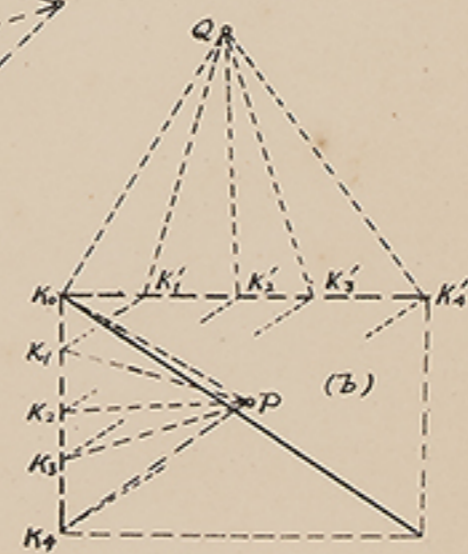
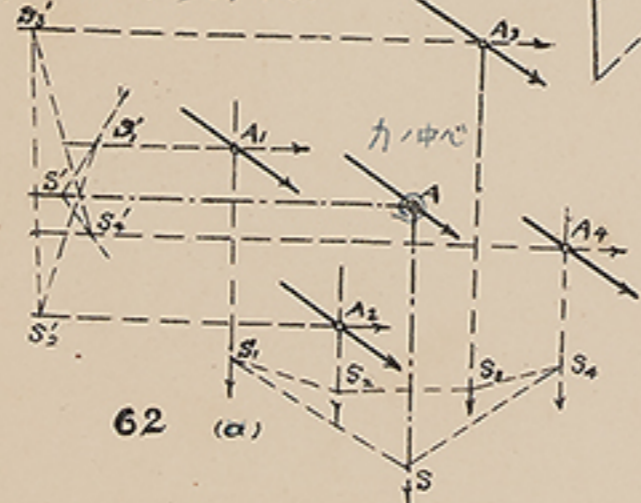

建築學會第一回講習會用

Centre of \parallel force = centroid, centre of force
 重心の中心
 重心 = mass centre or centre of gravity.

Ⅳ 支点反力

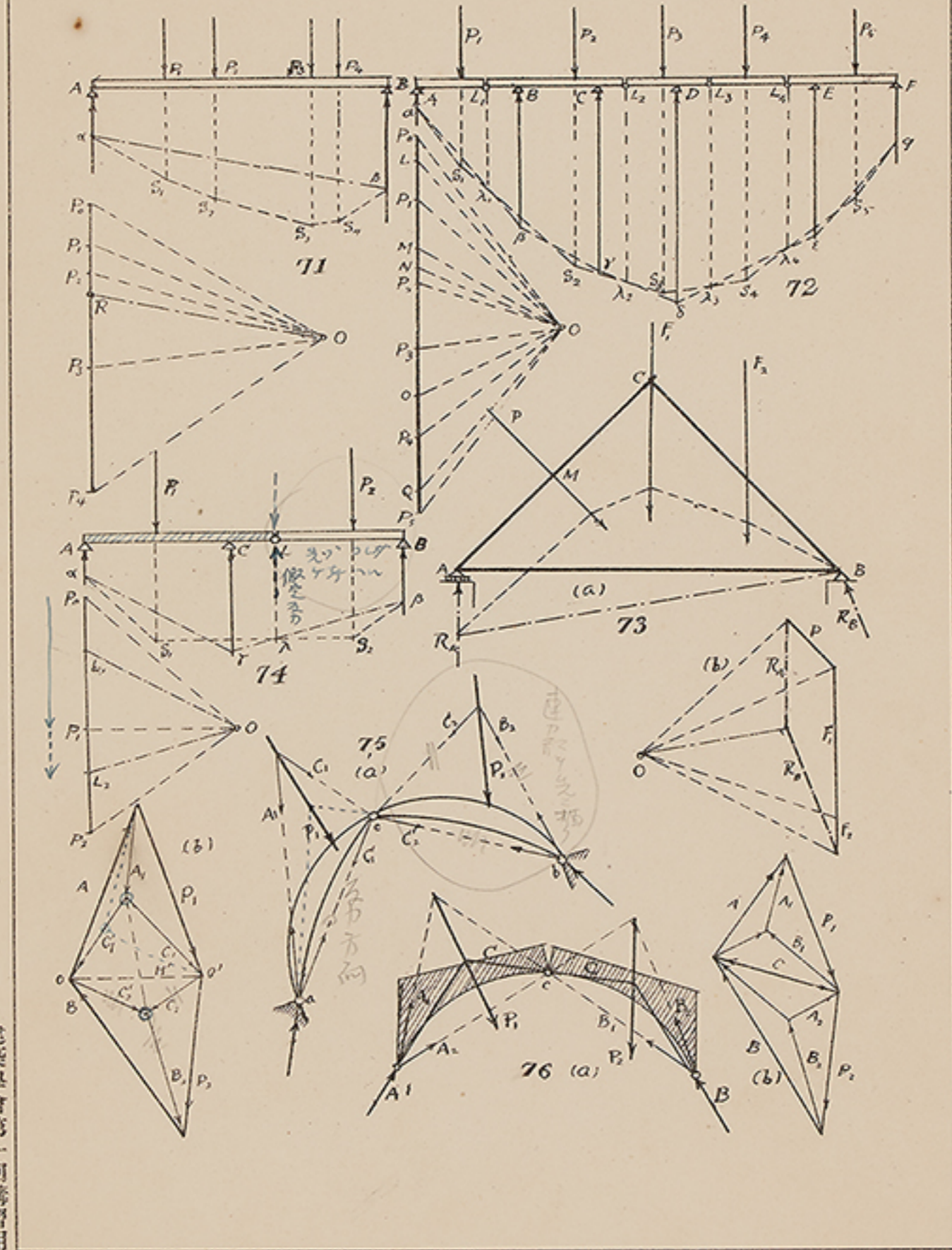

建築學會第一回講習用

non-complaner force.

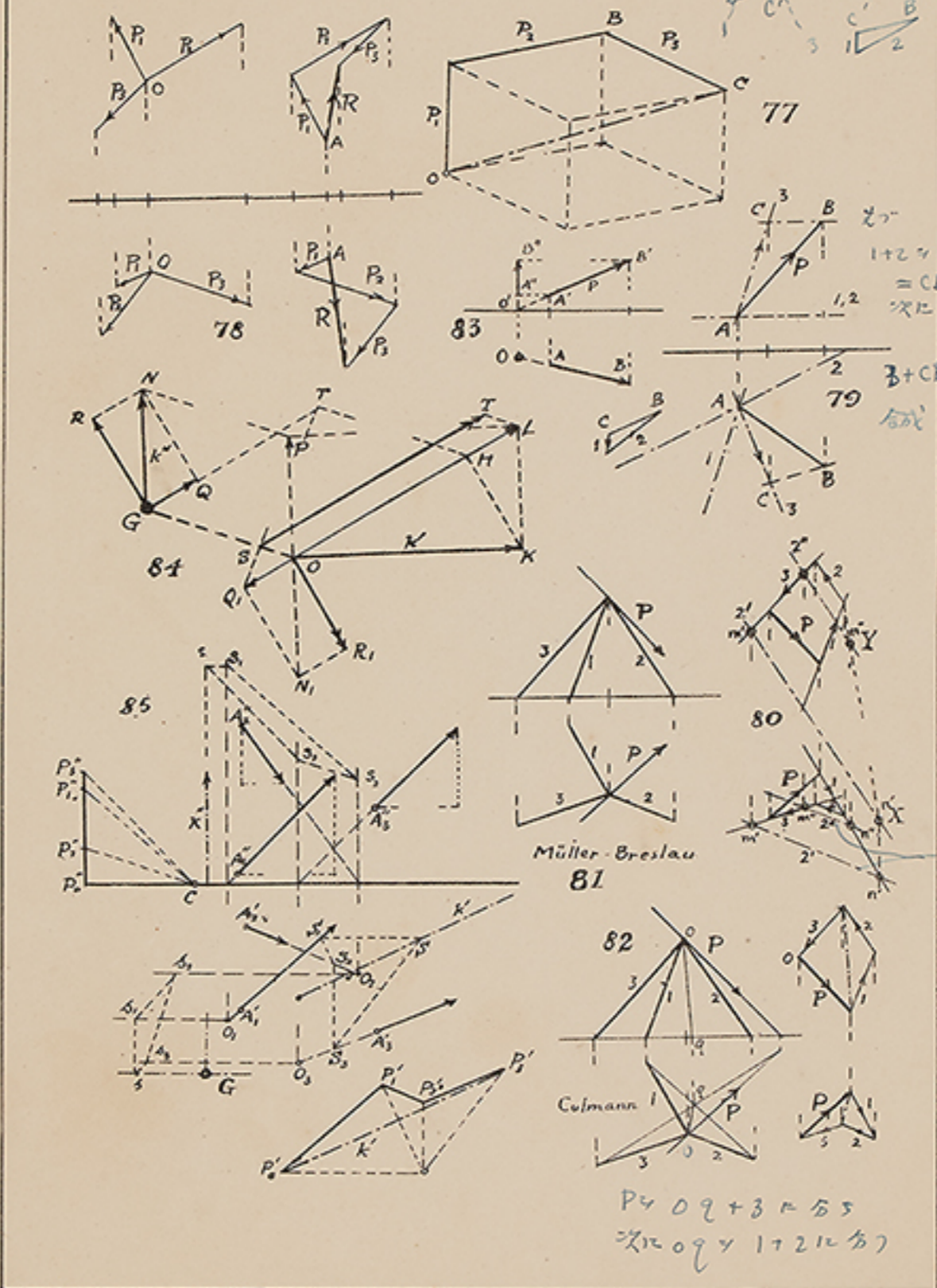

分解 C³B CBの挿入
CB' 1, 2に
分解す。

1+2の分の
=CB
次に

3+CBの分の
合成

planの
位置に
描く

$P \times 0.9 + 3 = 5.5$
次に $0.9 \times 1 + 2 = 2.9$

建築學會第一回講習會用

VII カの力学

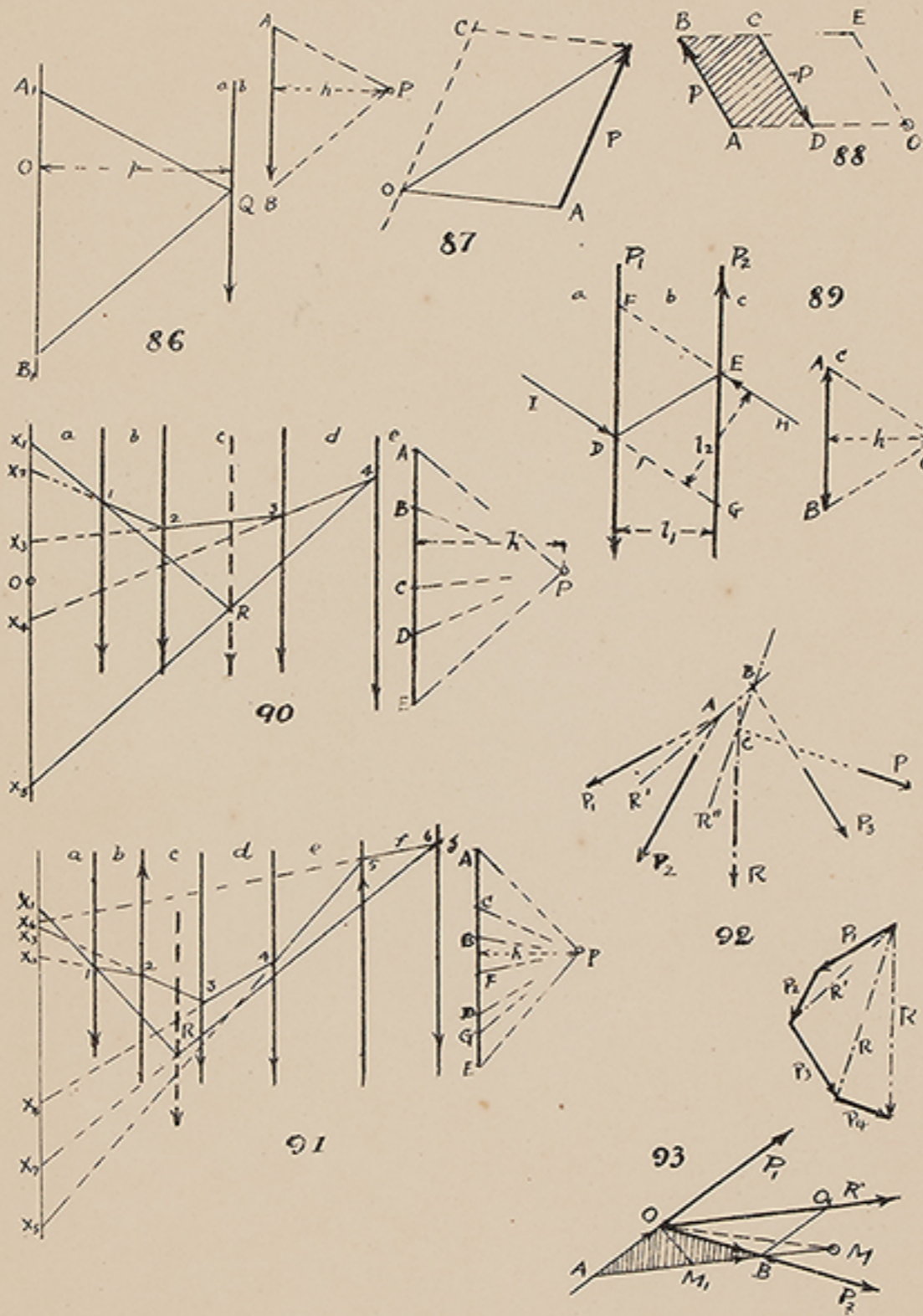

建築學會第一回講習會用

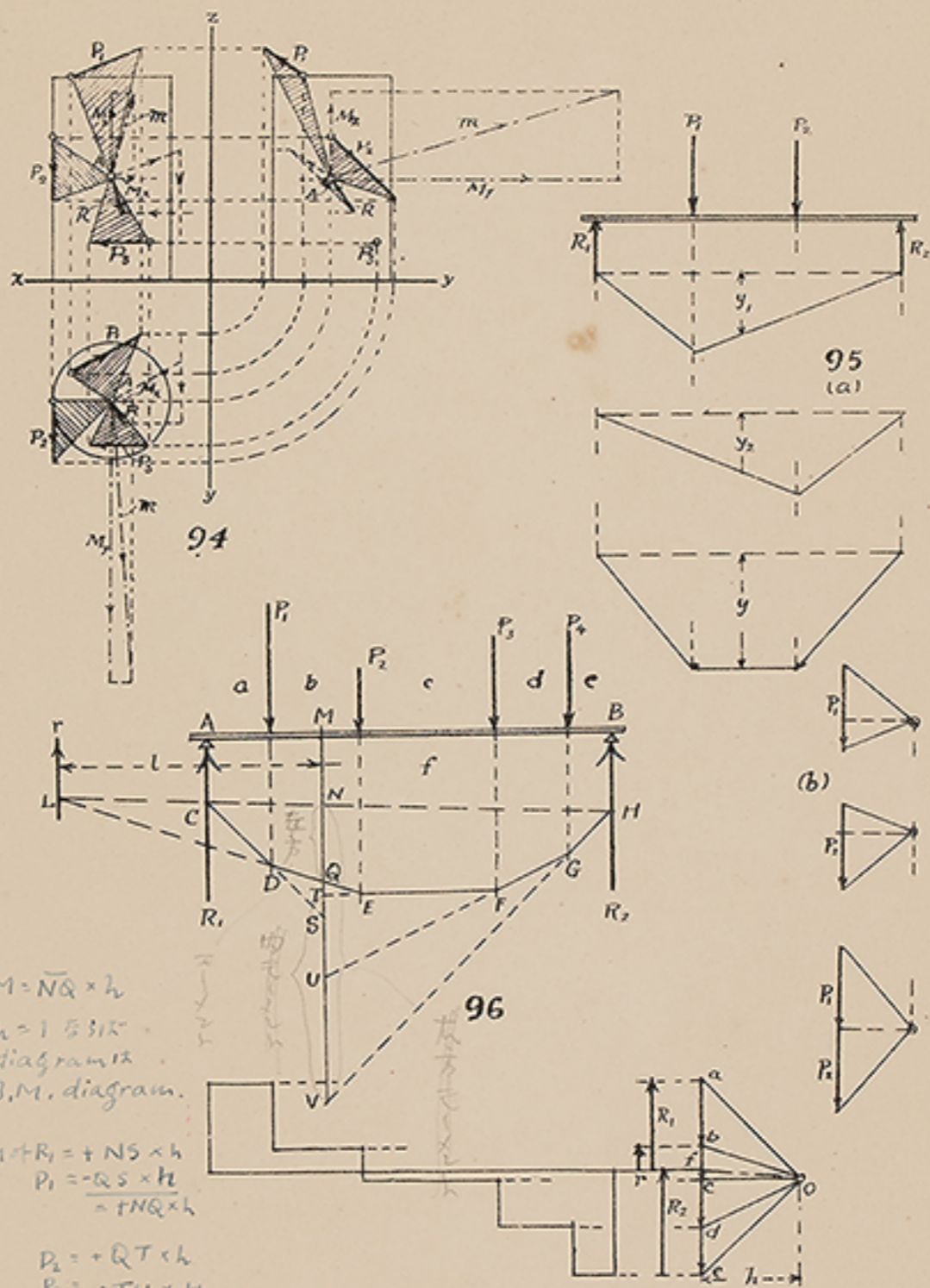

$M = \bar{N}Q \times h$
 $h = 1.531x$
 diagram
 B.M. diagram.
 $M + R_1 = +NS \times h$
 $P_1 = -QS \times h$
 $\quad = -NQ \times h$
 $P_2 = +QT \times h$
 $P_3 = +TU \times H$
 $P_4 = +UV \times H$
 $P_2 = -NV \times H$
 $\quad = -NQ \times H$

建築學會第一回講習會用

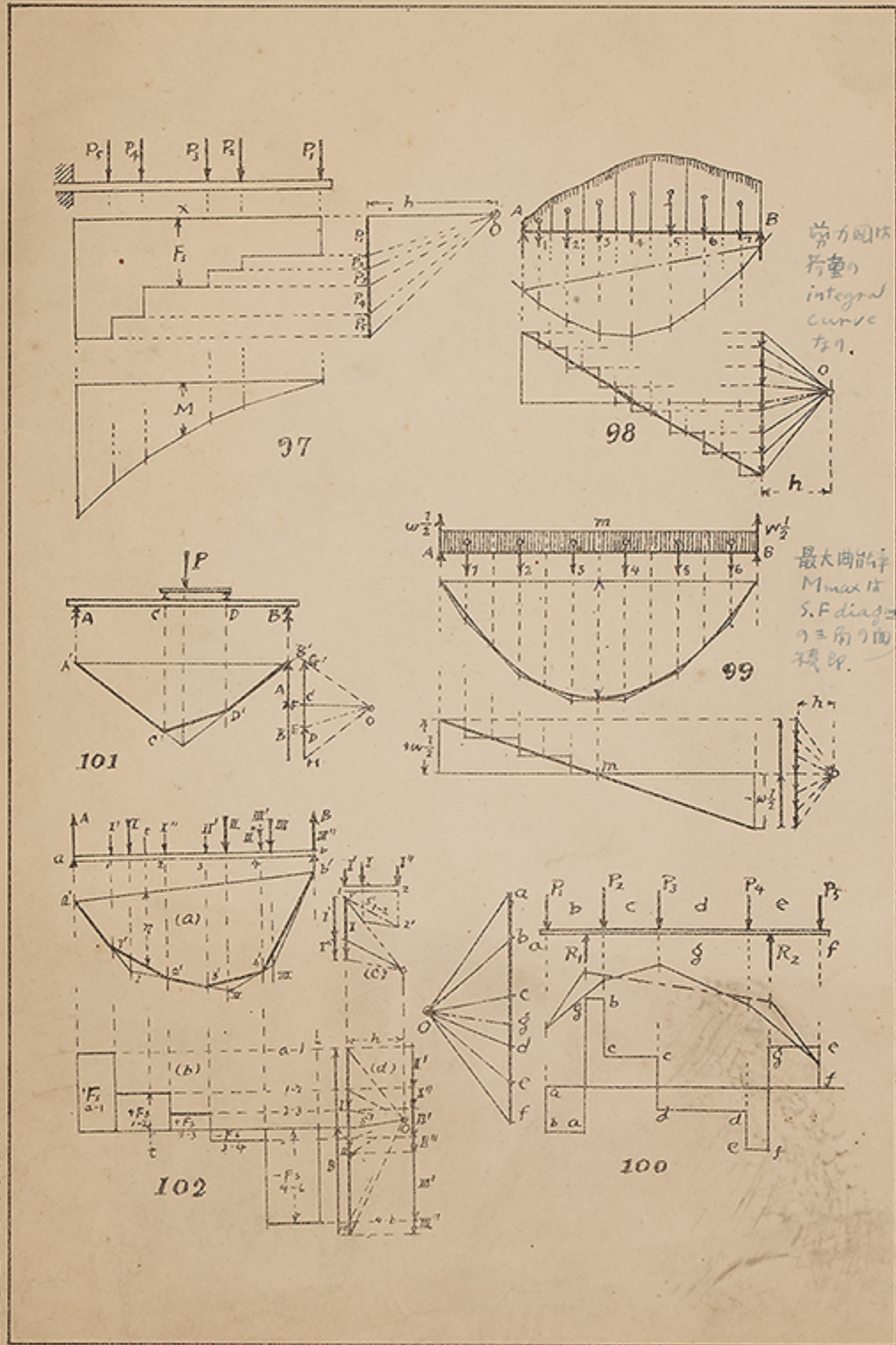

建築學會第一回講習用

$$\frac{M}{l} = \frac{S}{h} \quad M = Pl$$

$$P = \frac{S}{h}$$

この図は shear は
B.M の dip rate として知られ、
即ち水平の変化は shear, M の
rate of change.

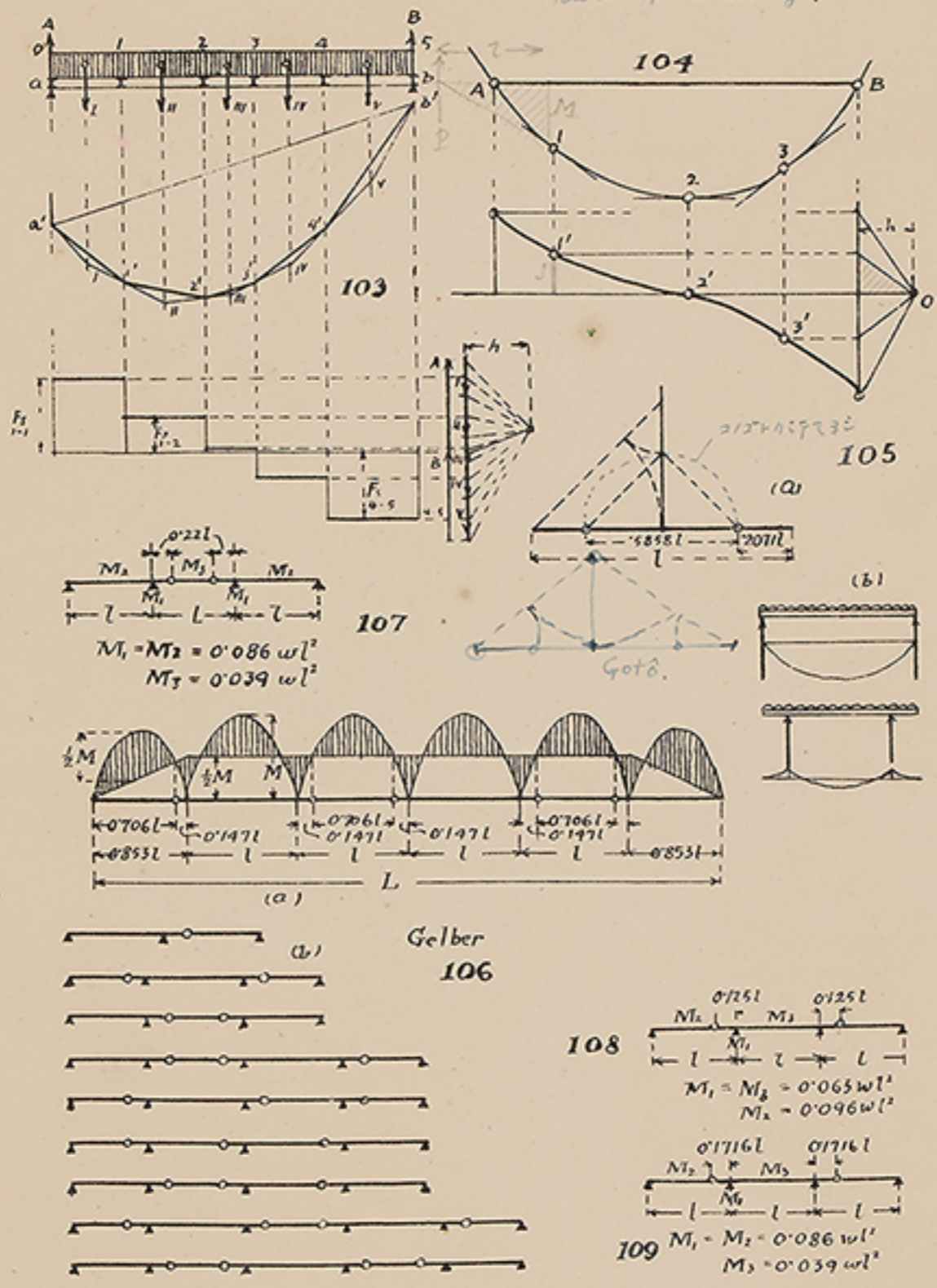

建築學會第一回講習會用

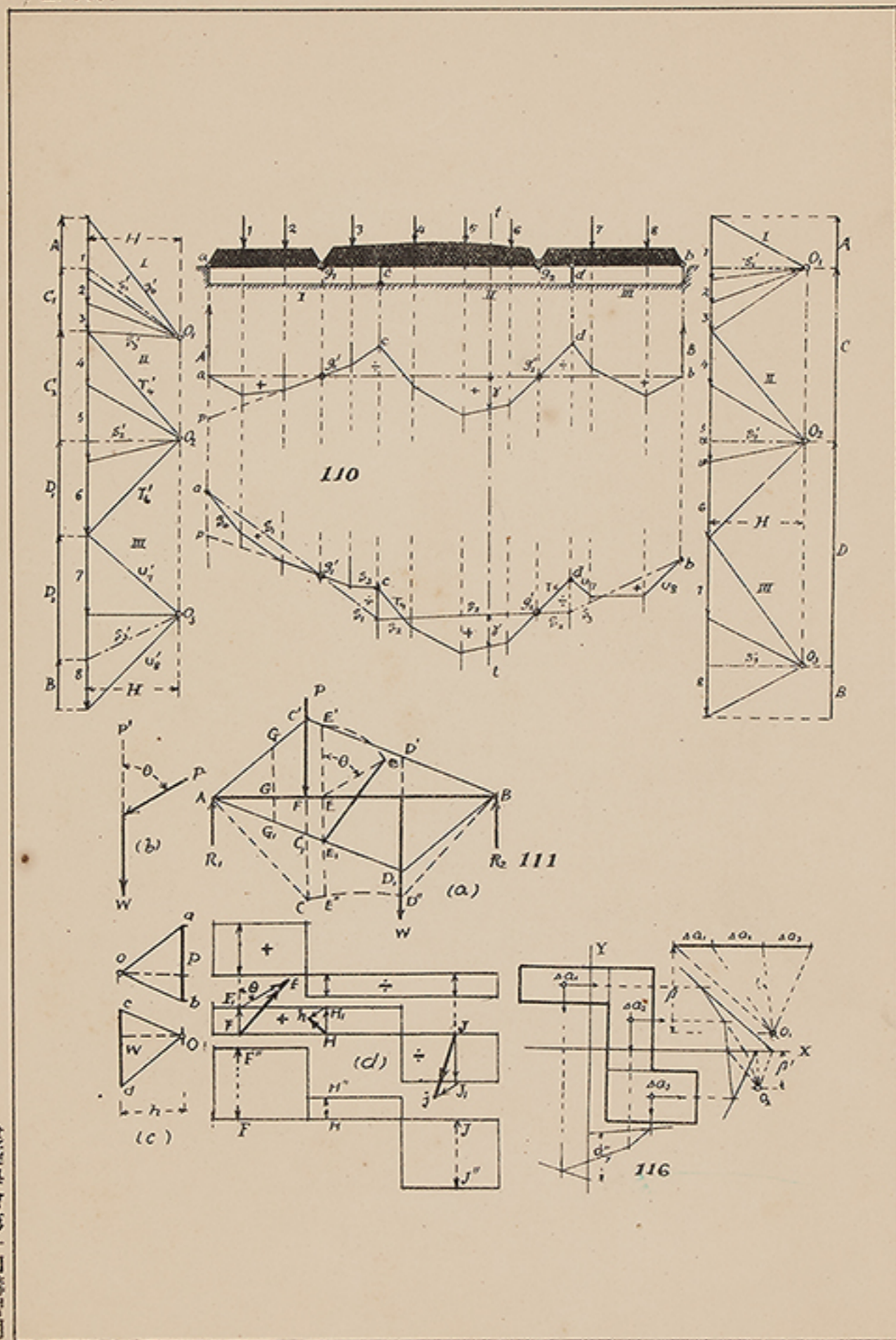

建築學會第一回講習用

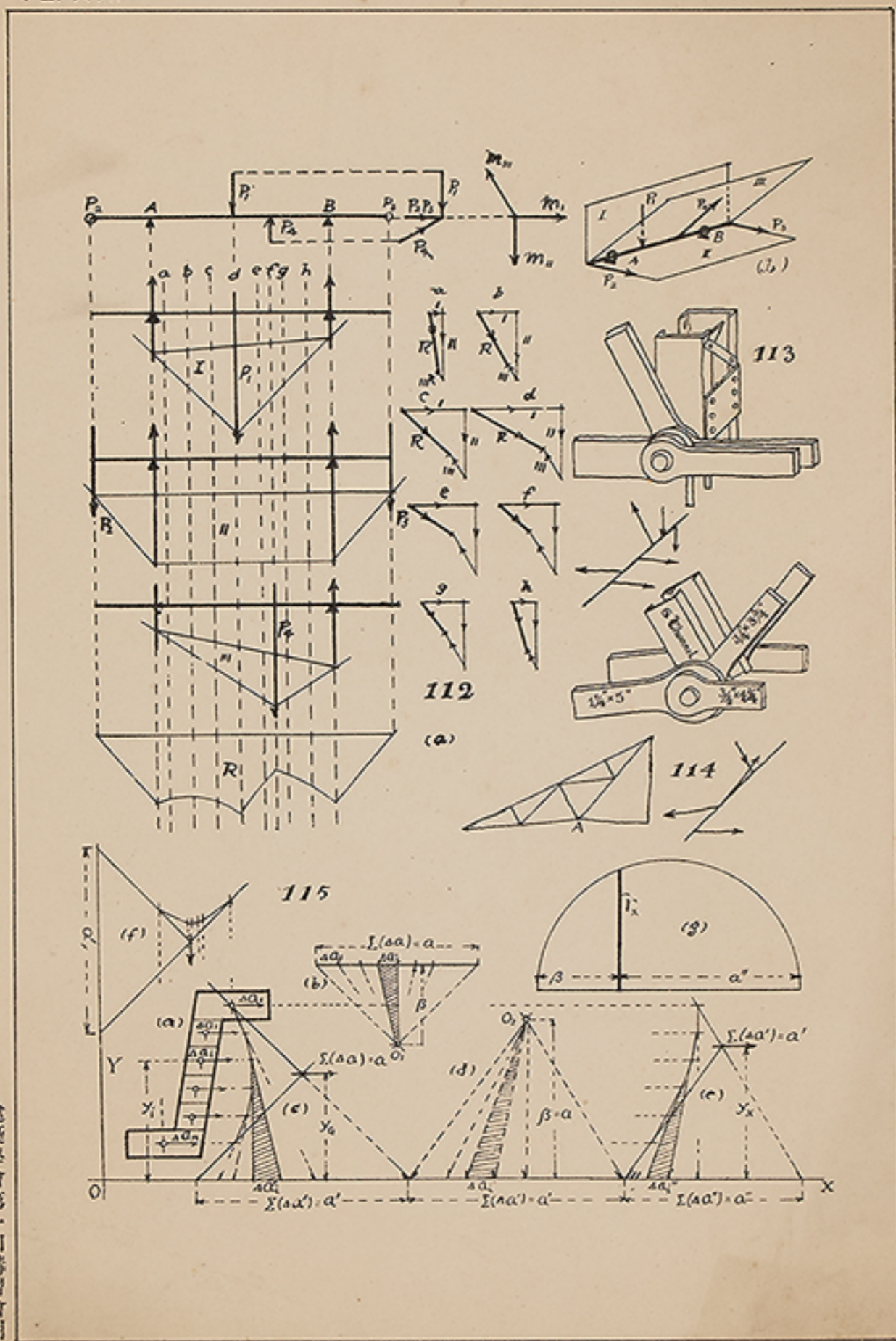

建築學會第一回講習會用

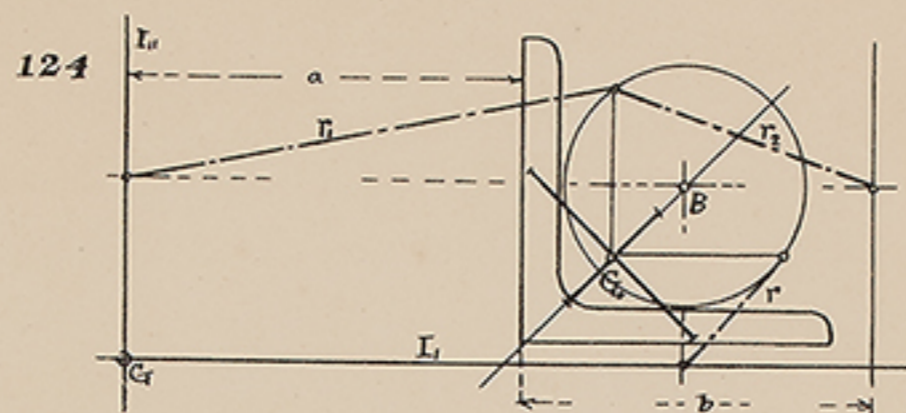

(Mehr-Land)



125

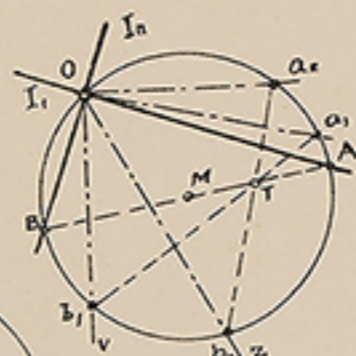

129

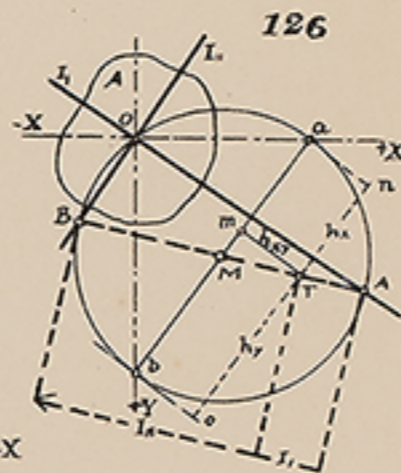

126

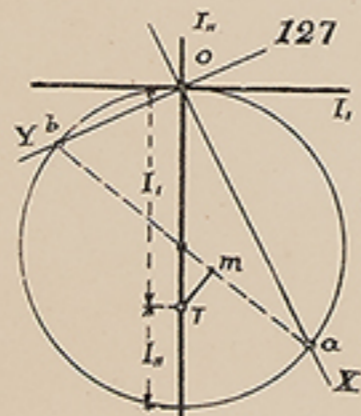

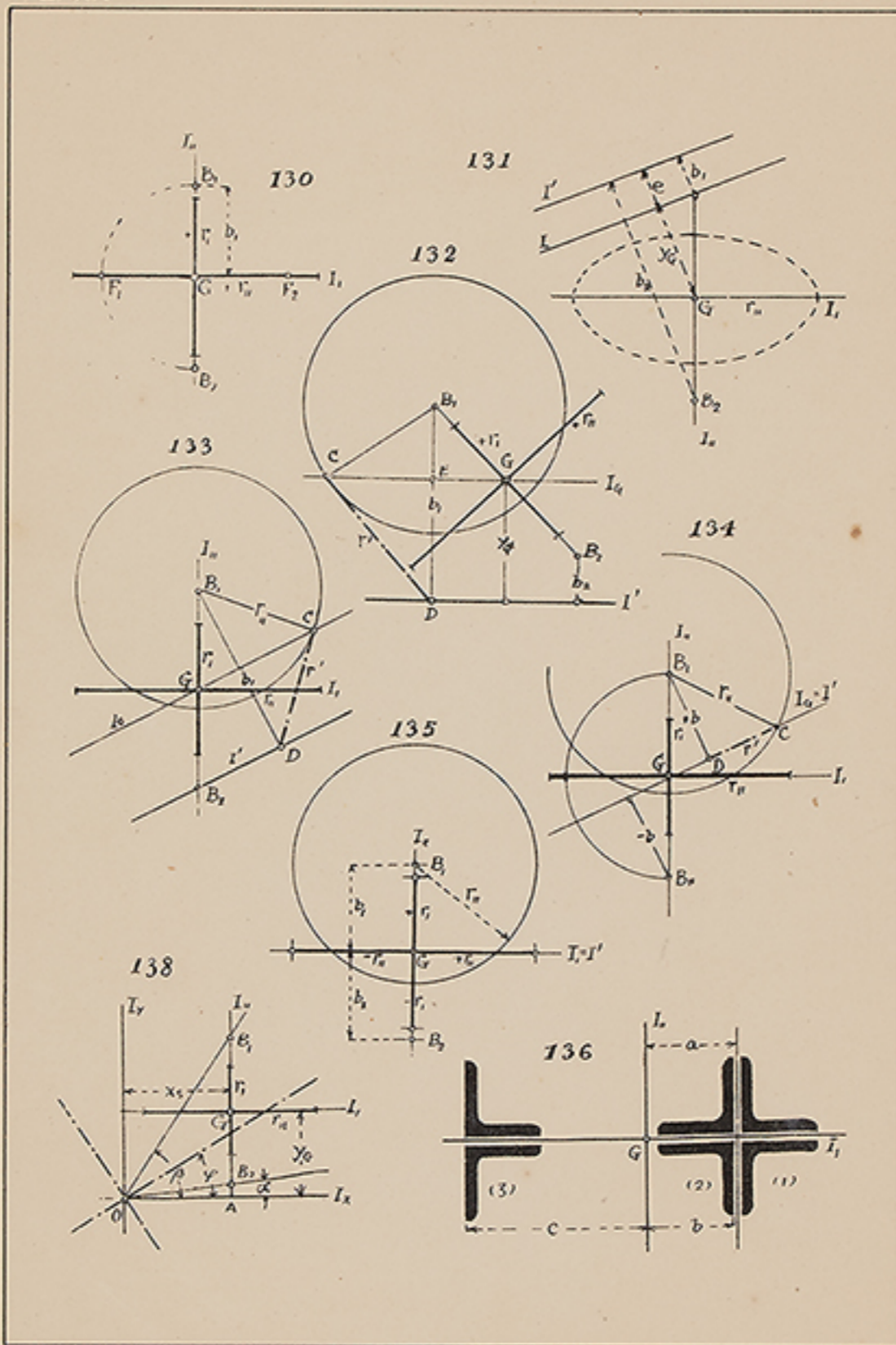

建築學會第一回講習會用

$A = 28.75$

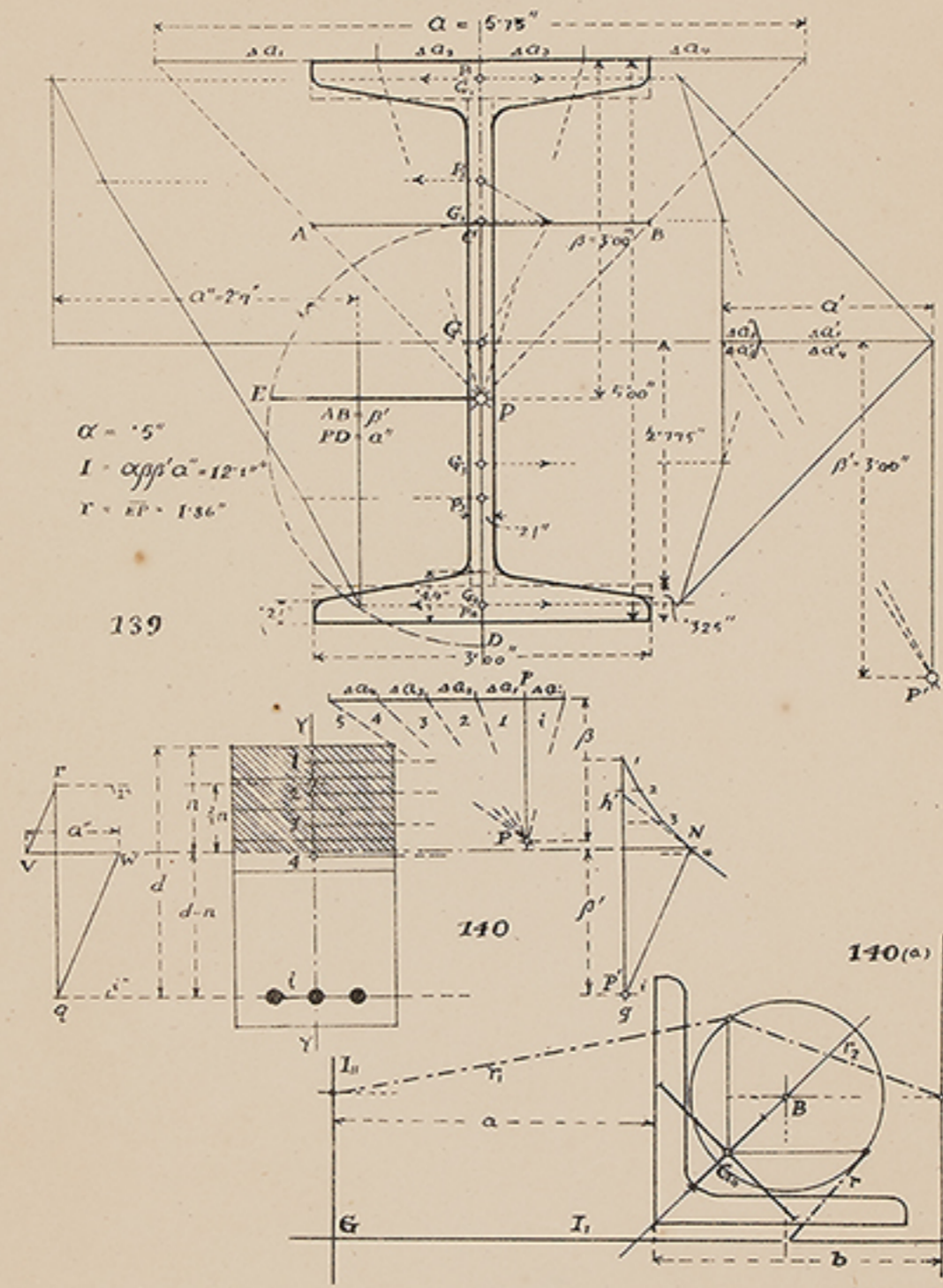

建築學會第一回講習用

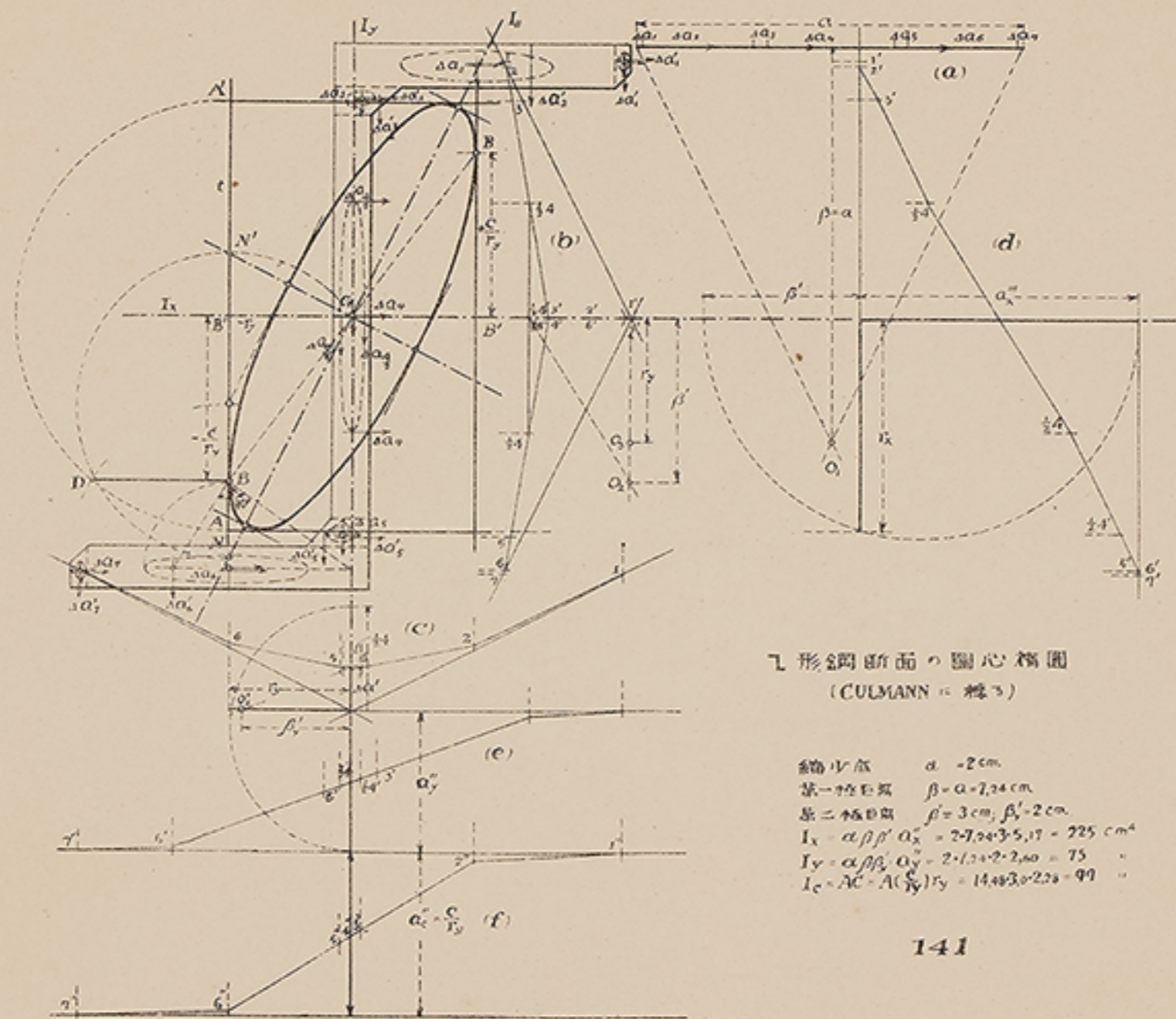

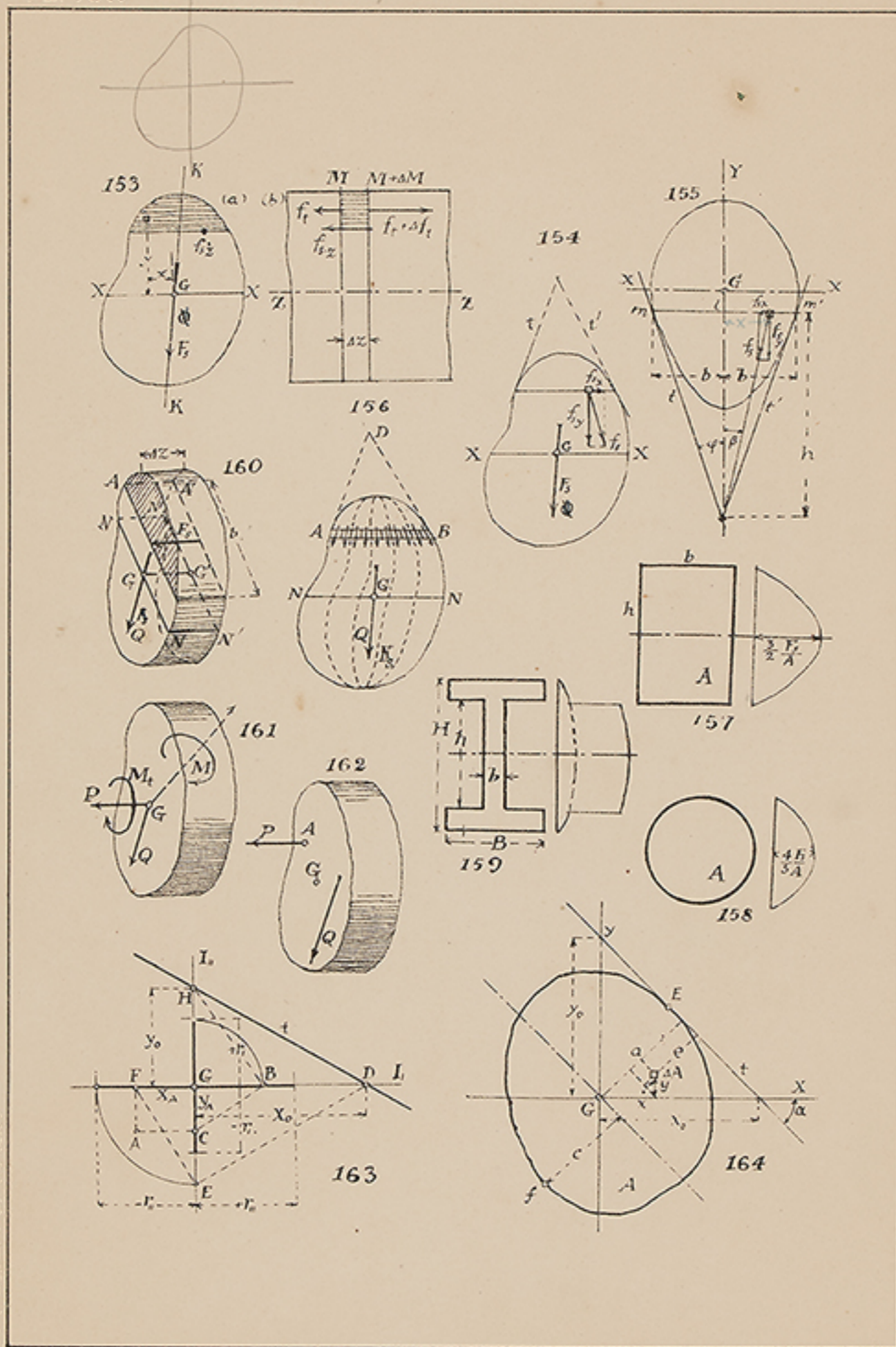

建築學會第一回講習會用

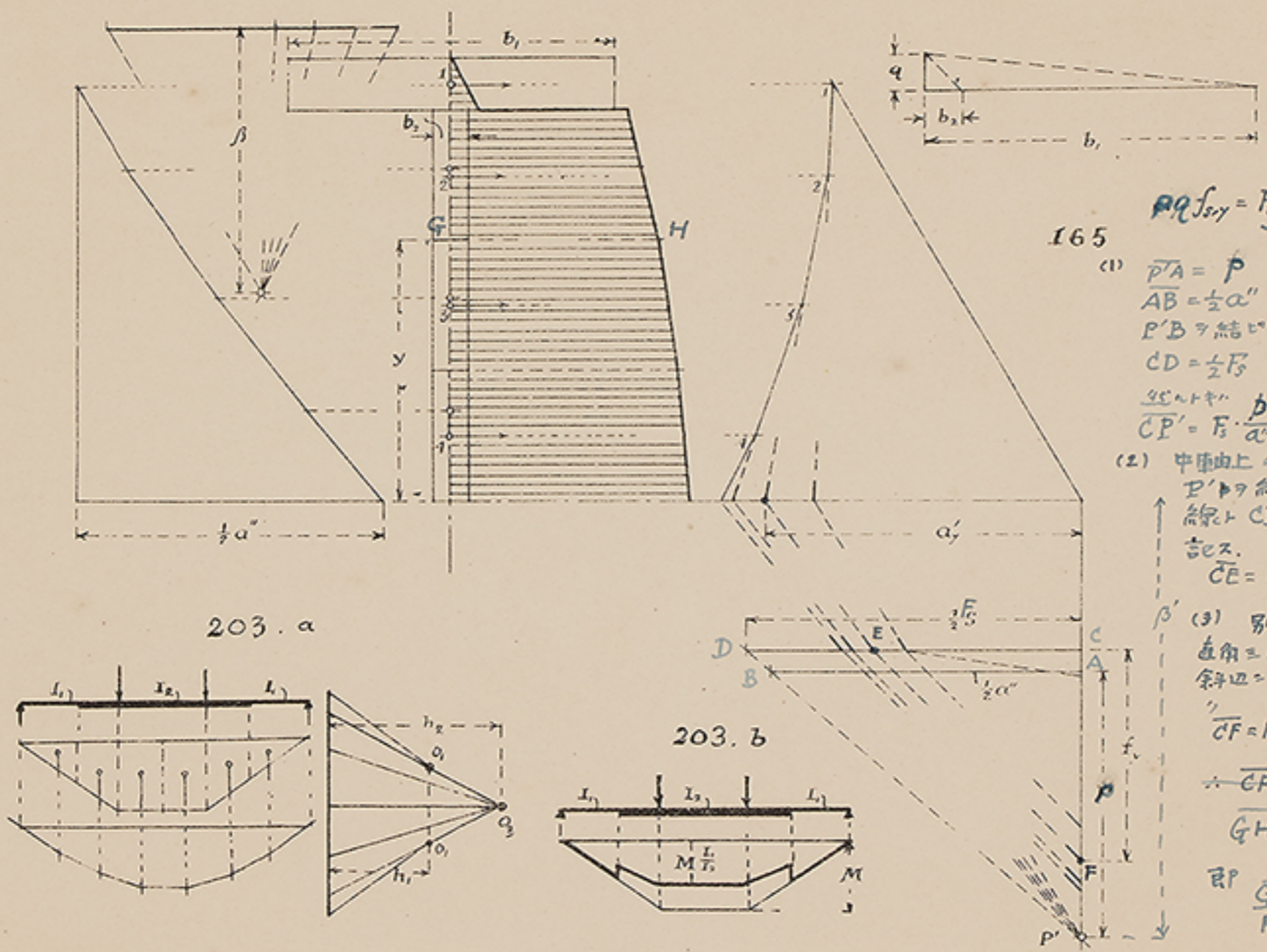

165

$$PQ f_{s,y} = F_s \cdot \frac{P}{a'} \cdot \frac{a'}{\beta'} \cdot \frac{z}{b_2}$$

(1) $\overline{PA} = p$
 $\overline{AB} = \frac{1}{2} a''$
 $P'B$ を結ぶ
 $\overline{CD} = \frac{1}{2} F_s$
 $\frac{z}{\beta' a' + \frac{1}{2} a''} = \frac{p}{a'}$

(2) 中軸上の $\Delta A'$ 点ト
 P' トヲ結ブ. 該連結
 線ト CD トノ交点ヲ
 記ス.
 $\overline{CE} = F_s \cdot \frac{\beta}{a'} \cdot \frac{a'}{\beta'}$

(3) 別ト q 及 $b_2 = \gamma$
 直角三角ヲ作リ,
 斜辺 = 平行 = EF ヲ描
 $\overline{CF} = F_s \cdot \frac{p}{a'} \cdot \frac{a'}{\beta'} \cdot \frac{z}{b_2}$
 $\overline{CF} \cdot \frac{a}{z} = \alpha \beta f_{s,y}$
 $\overline{GH} = \overline{CF}$ ト作ル
 即 $\frac{\overline{GH}}{P \cdot q} = f_{s,y}$

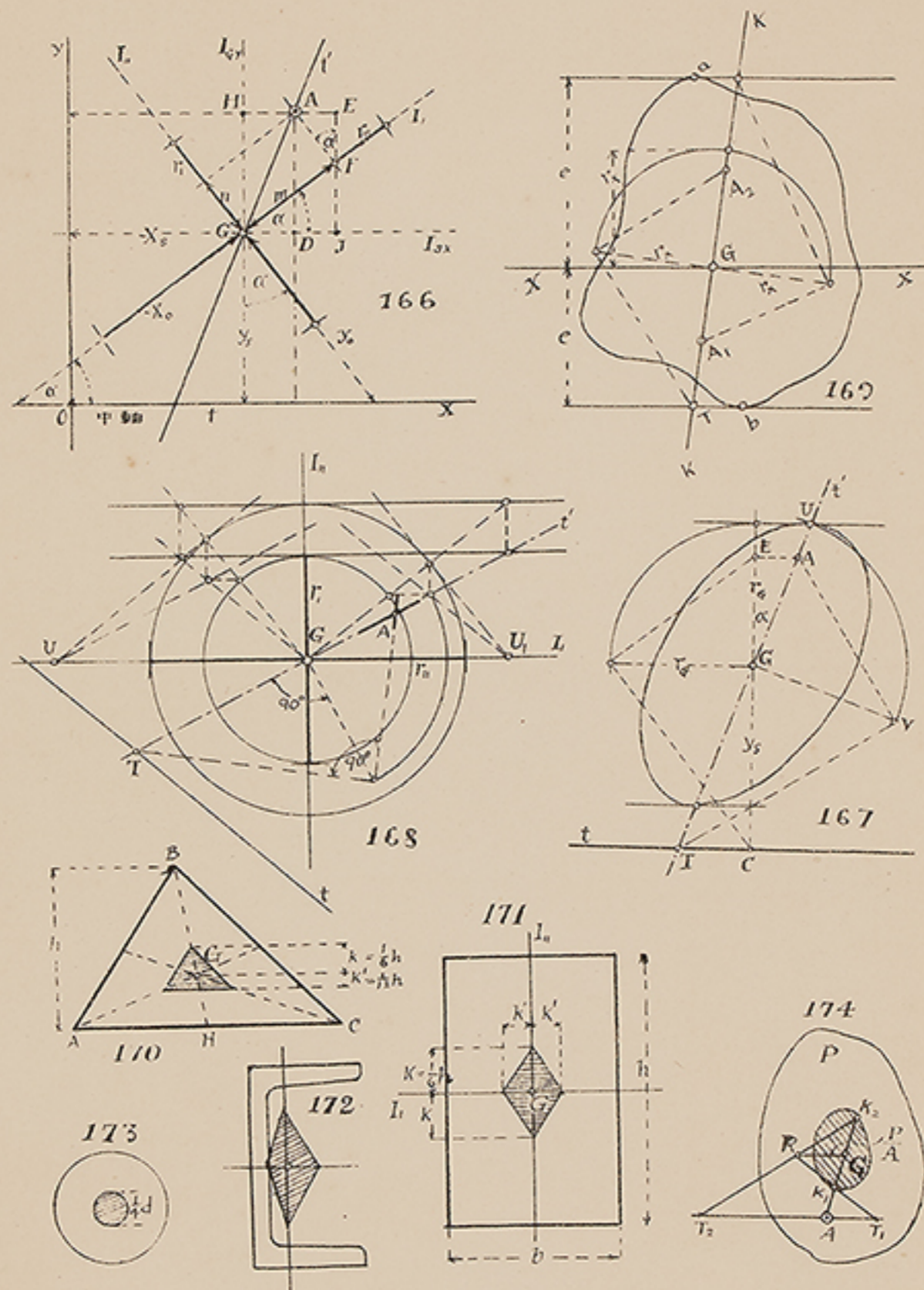

建築學會第一回講習用

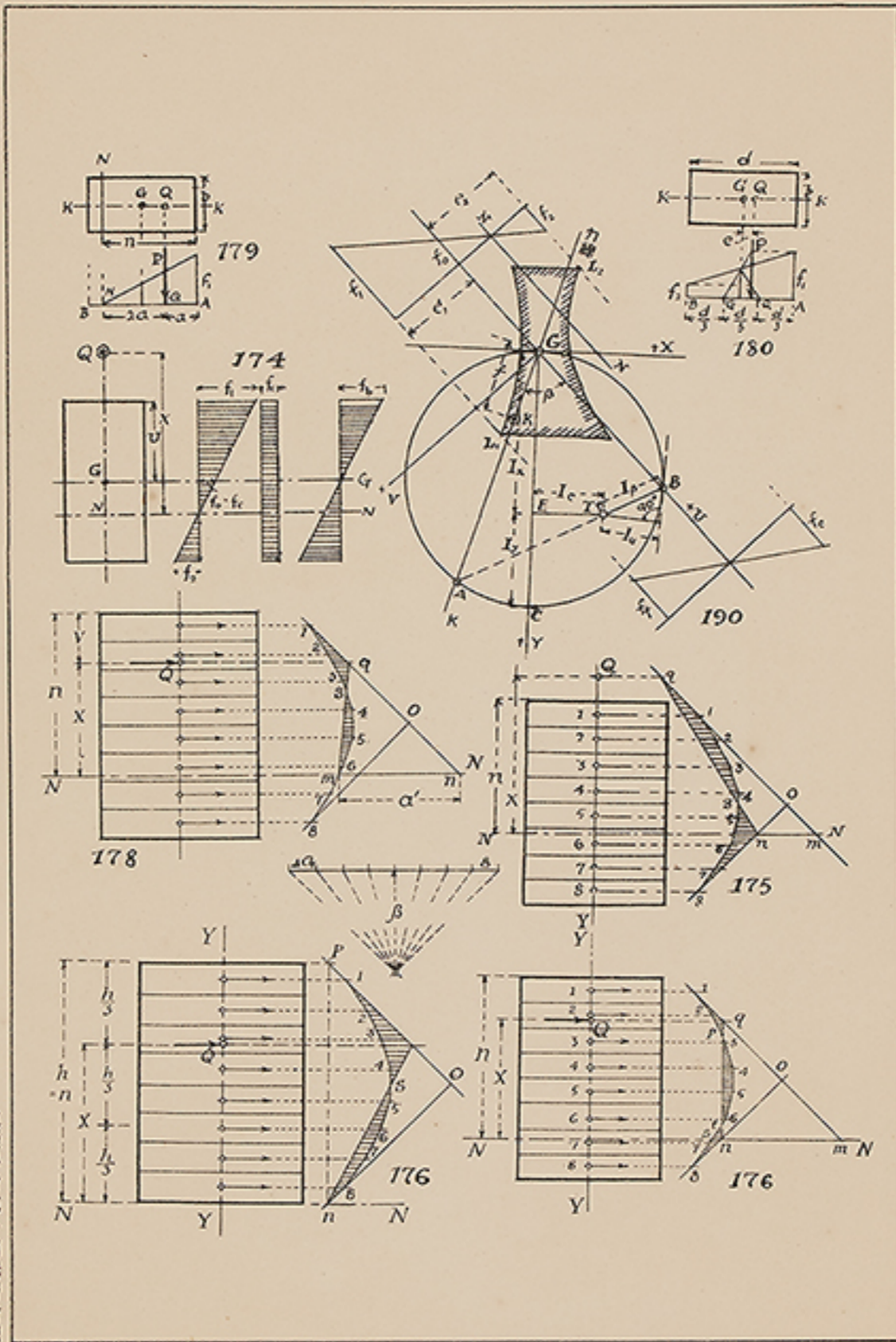

建築學會第二回講習會用

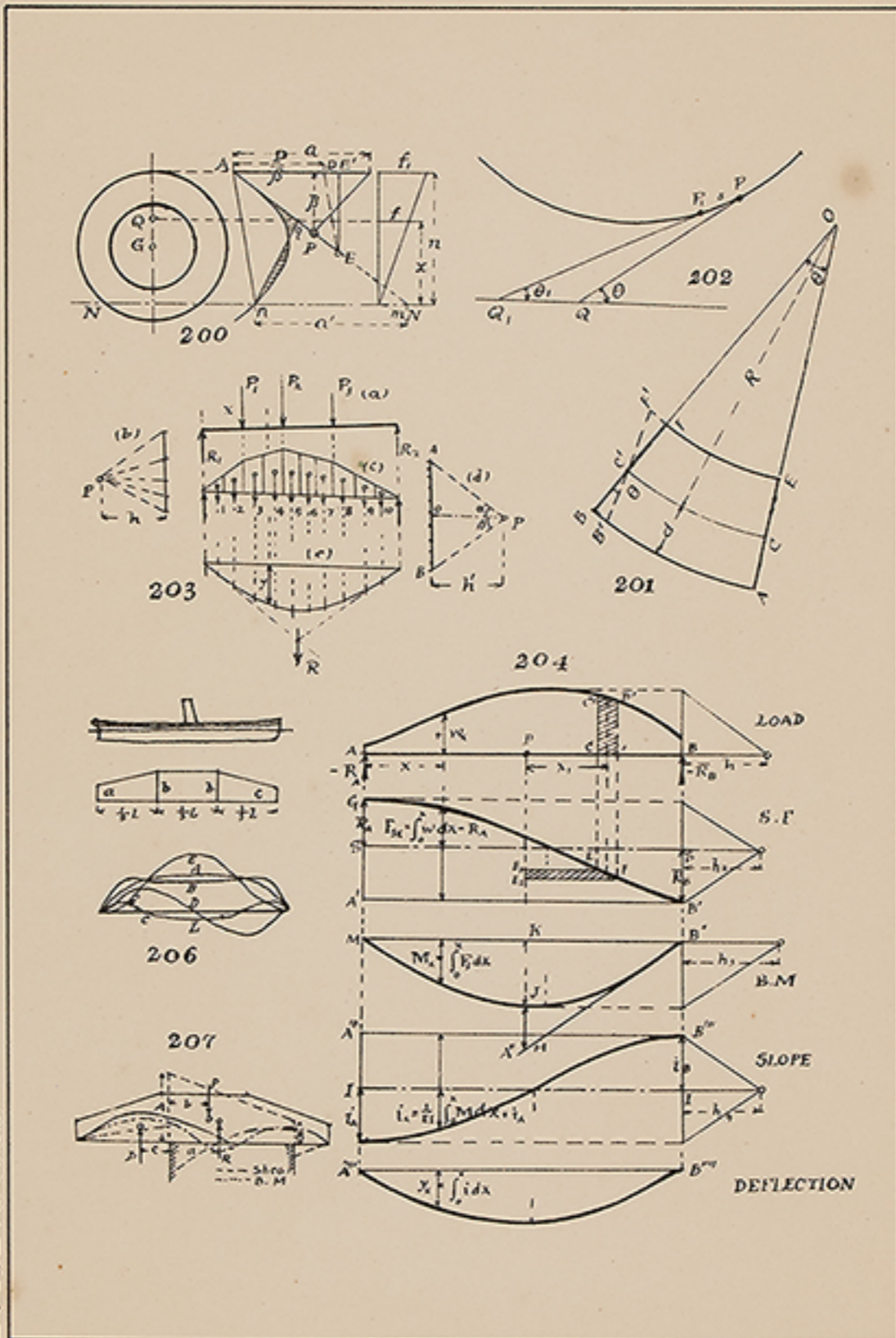

建築學會第一回講習會用

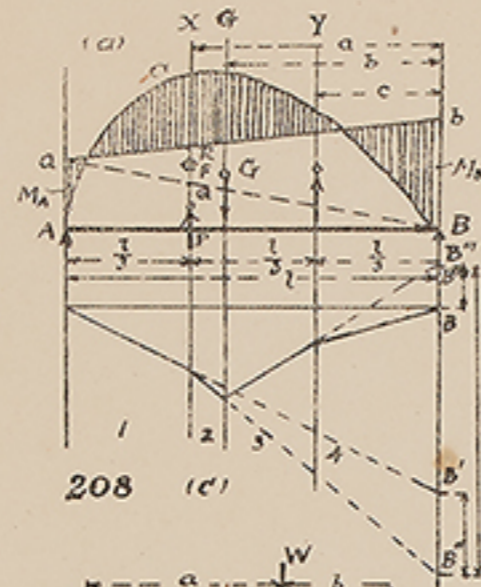

208 (c')

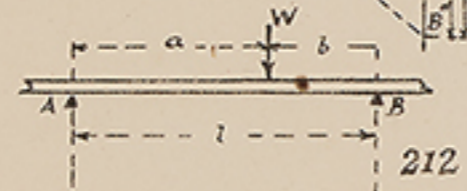

212

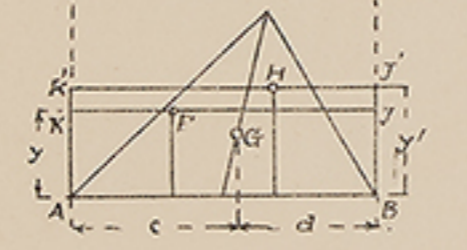

213

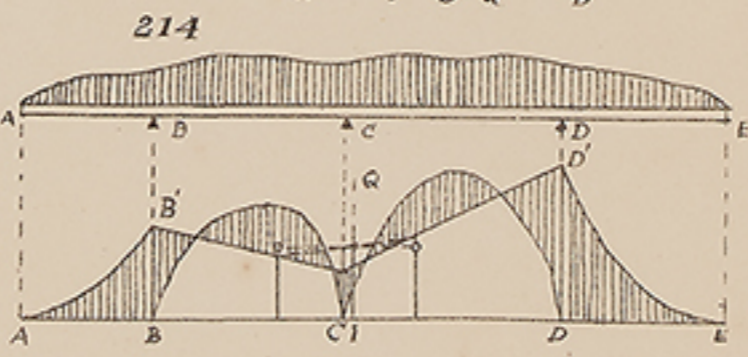
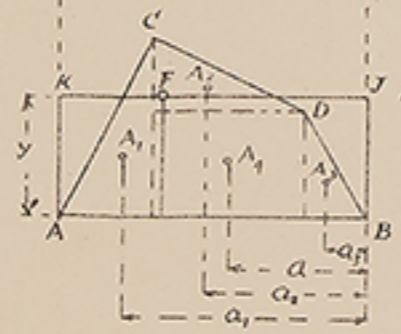

214

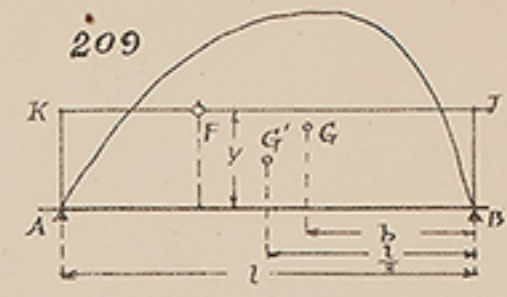

209

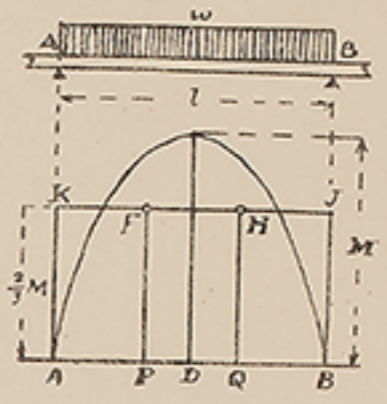

210

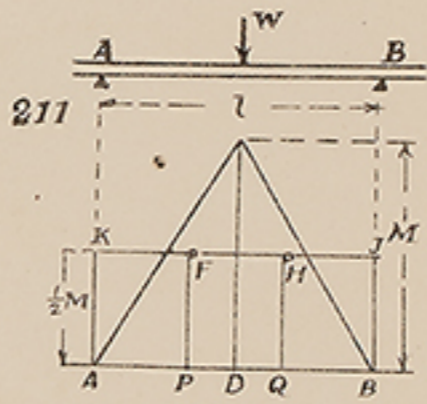

211

建築學會第一回講習用

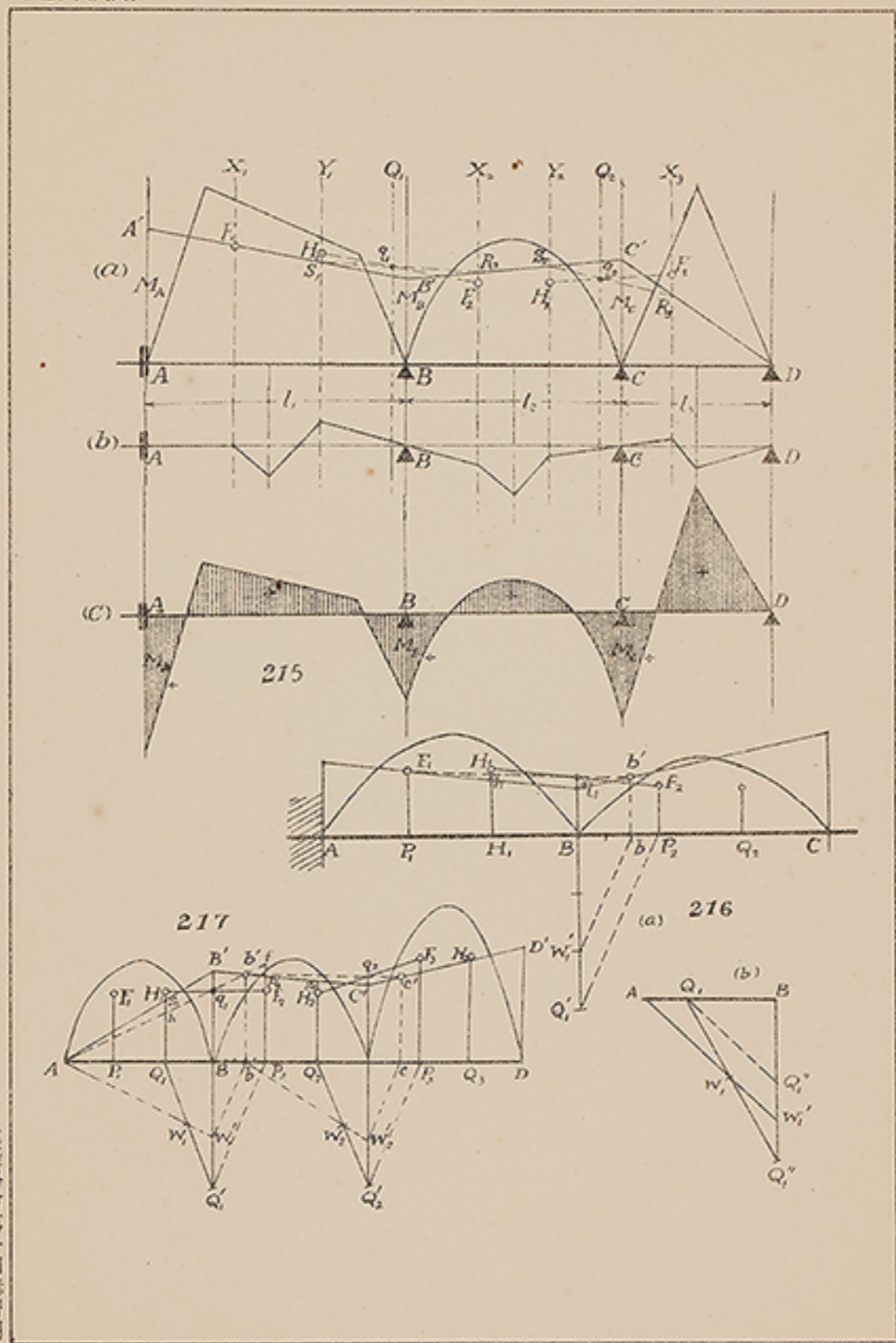

建築學會第一回講習用

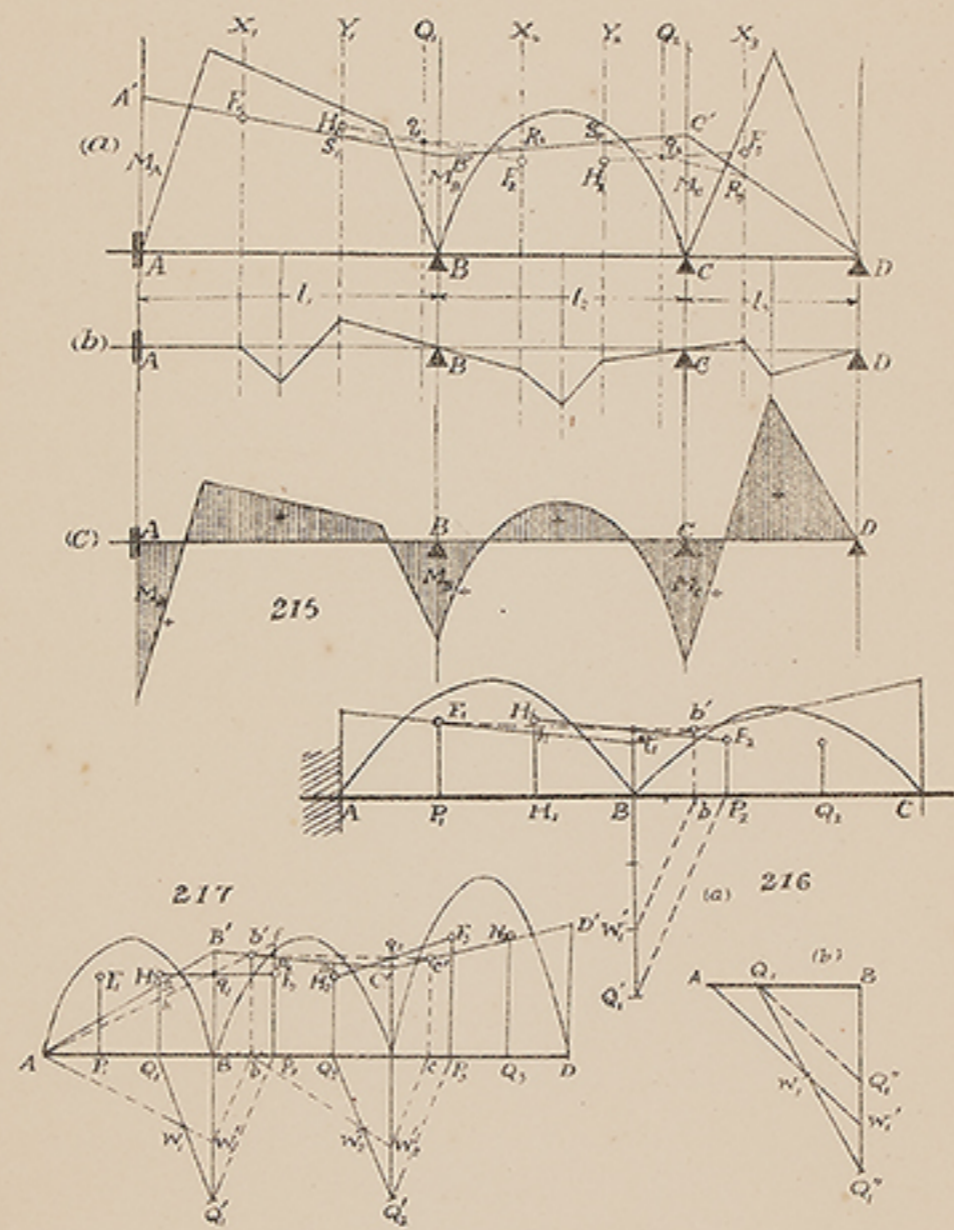

建築學會第一回講習用

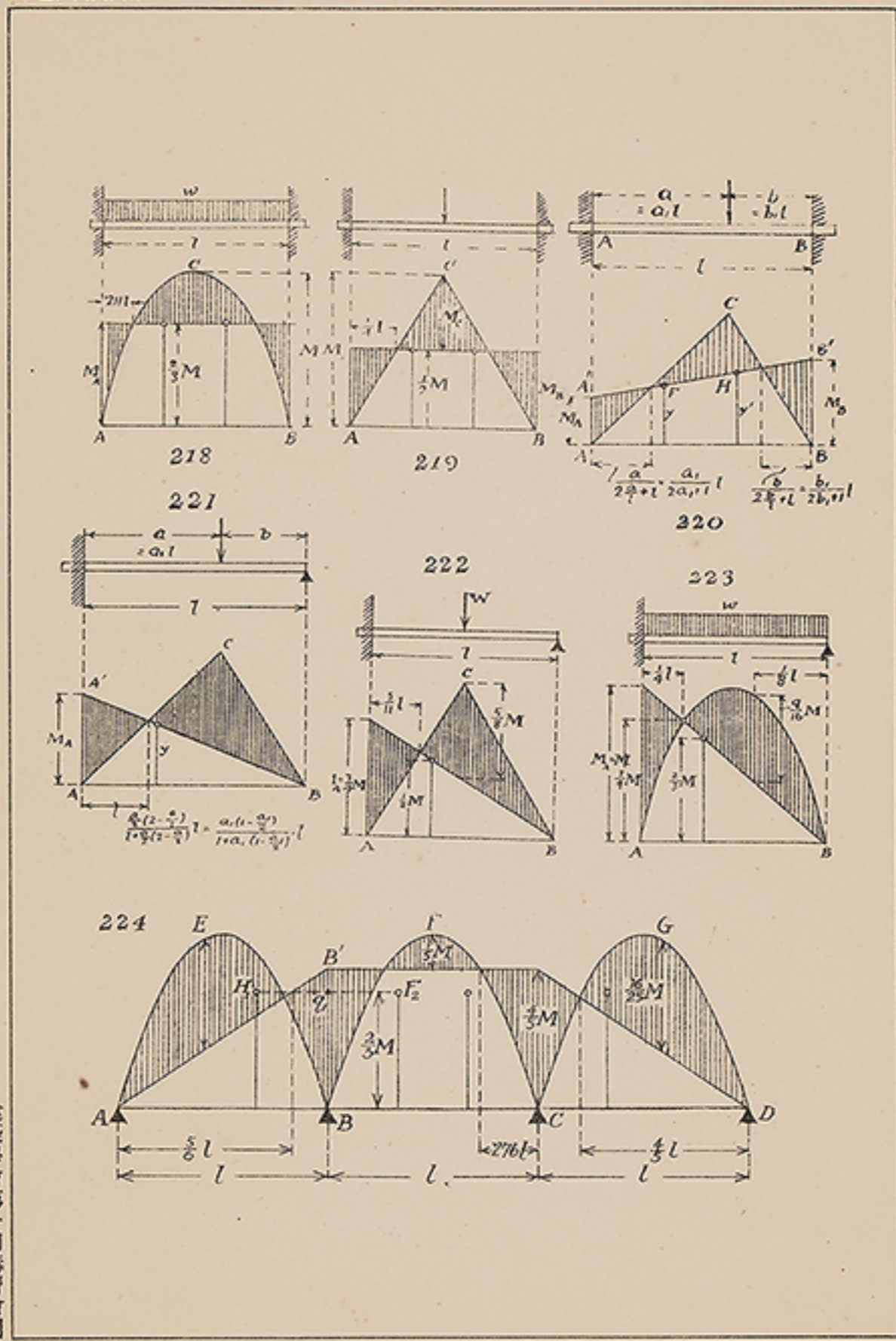

建築學會第一回講習會用

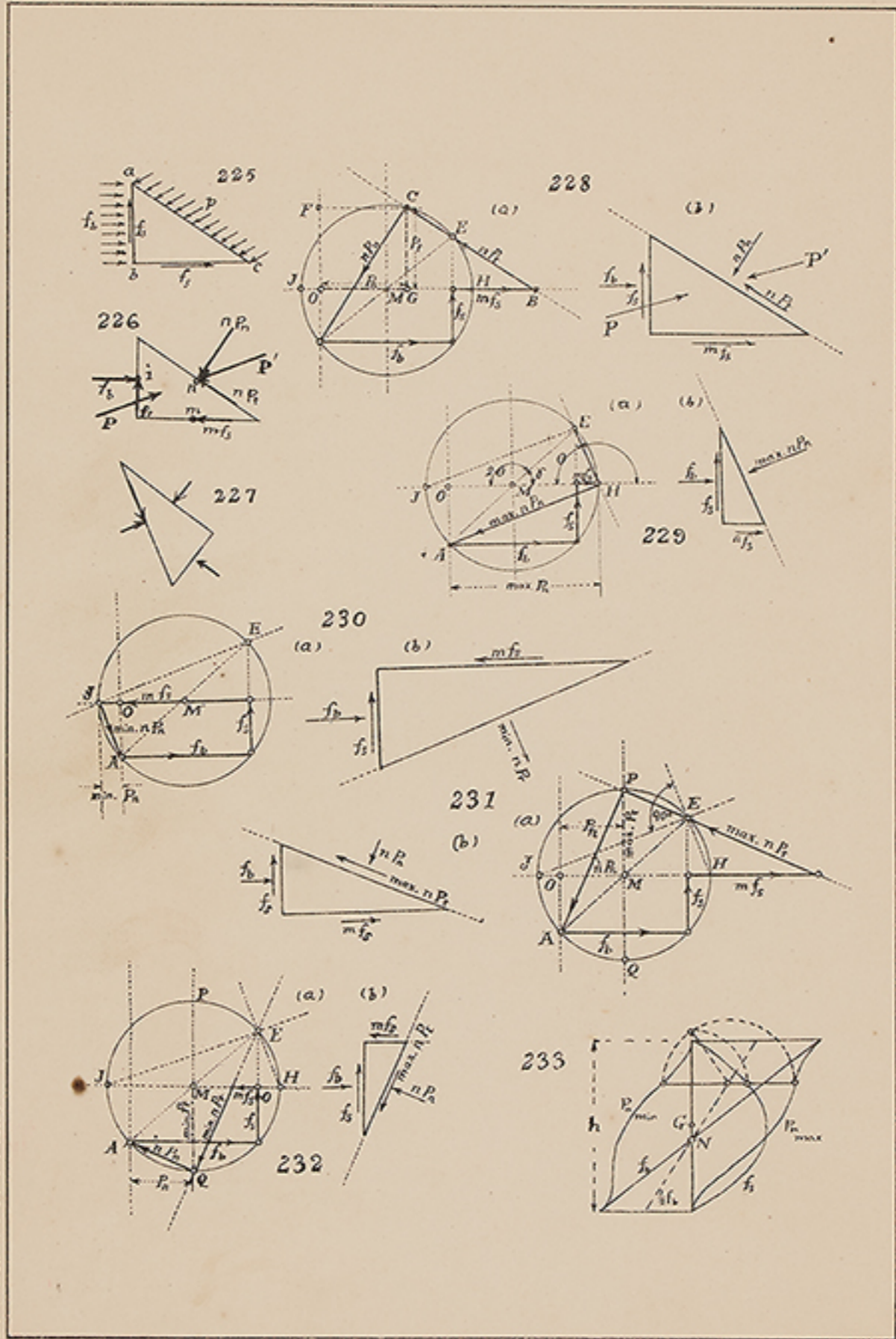

建築學會第一回講習會用

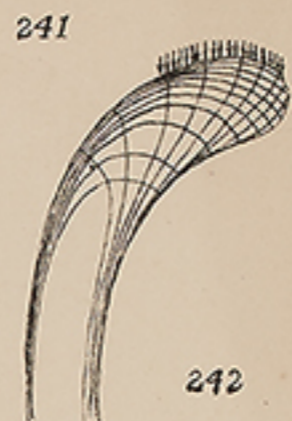

242



243



244

245



建築學會第一回講習會用

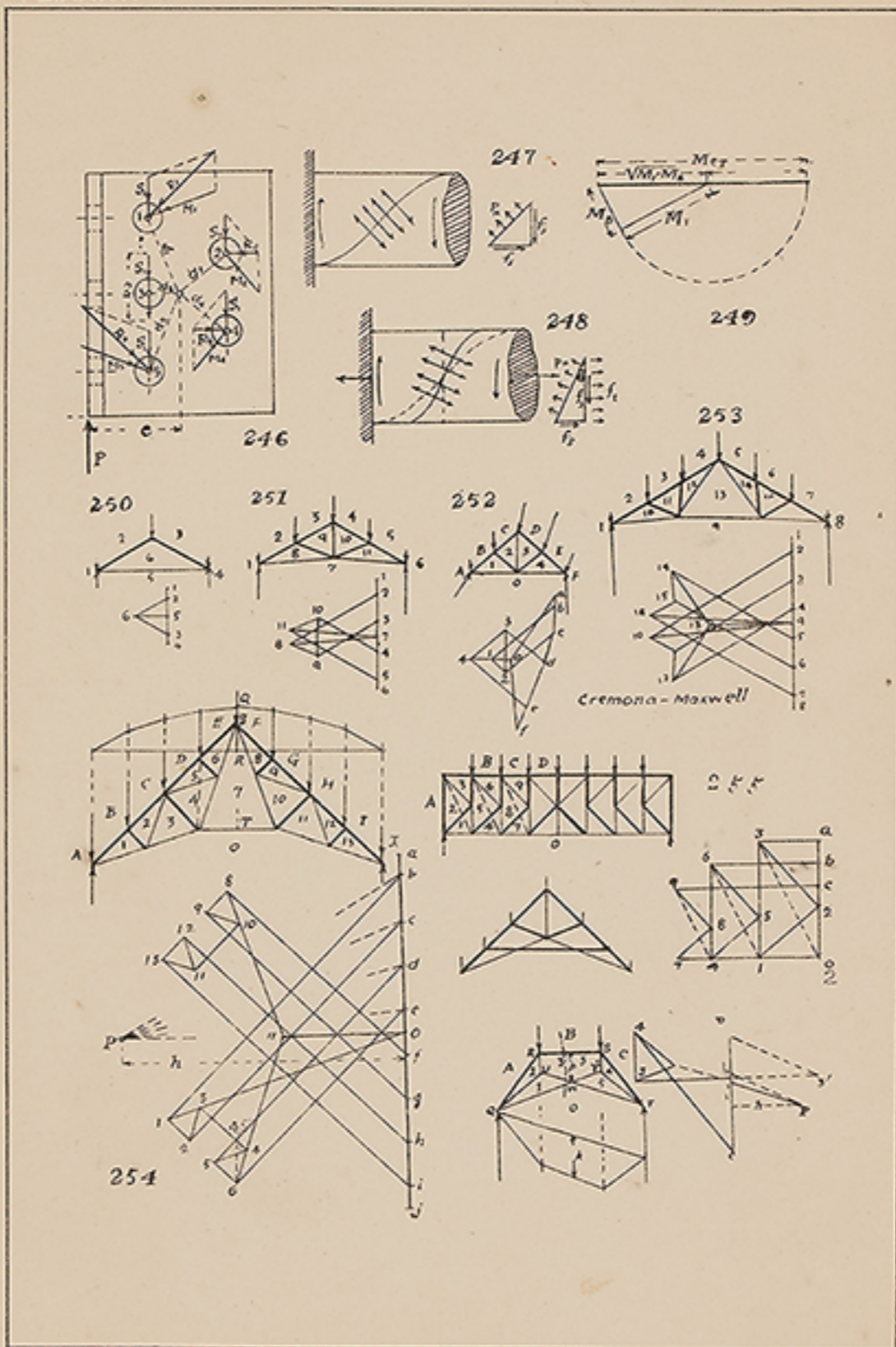

建築學會第二回講習會用

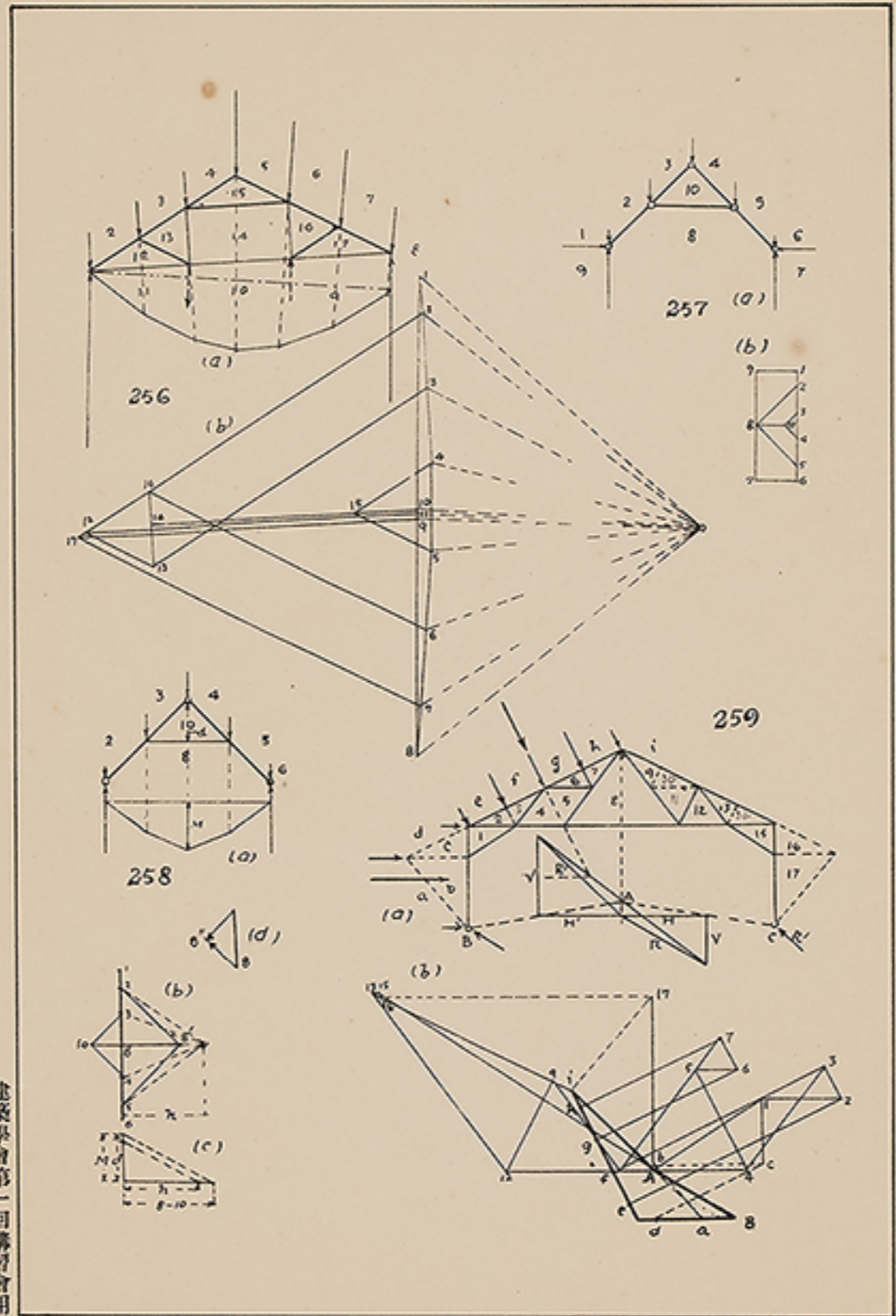

建築學會第一回講習會用

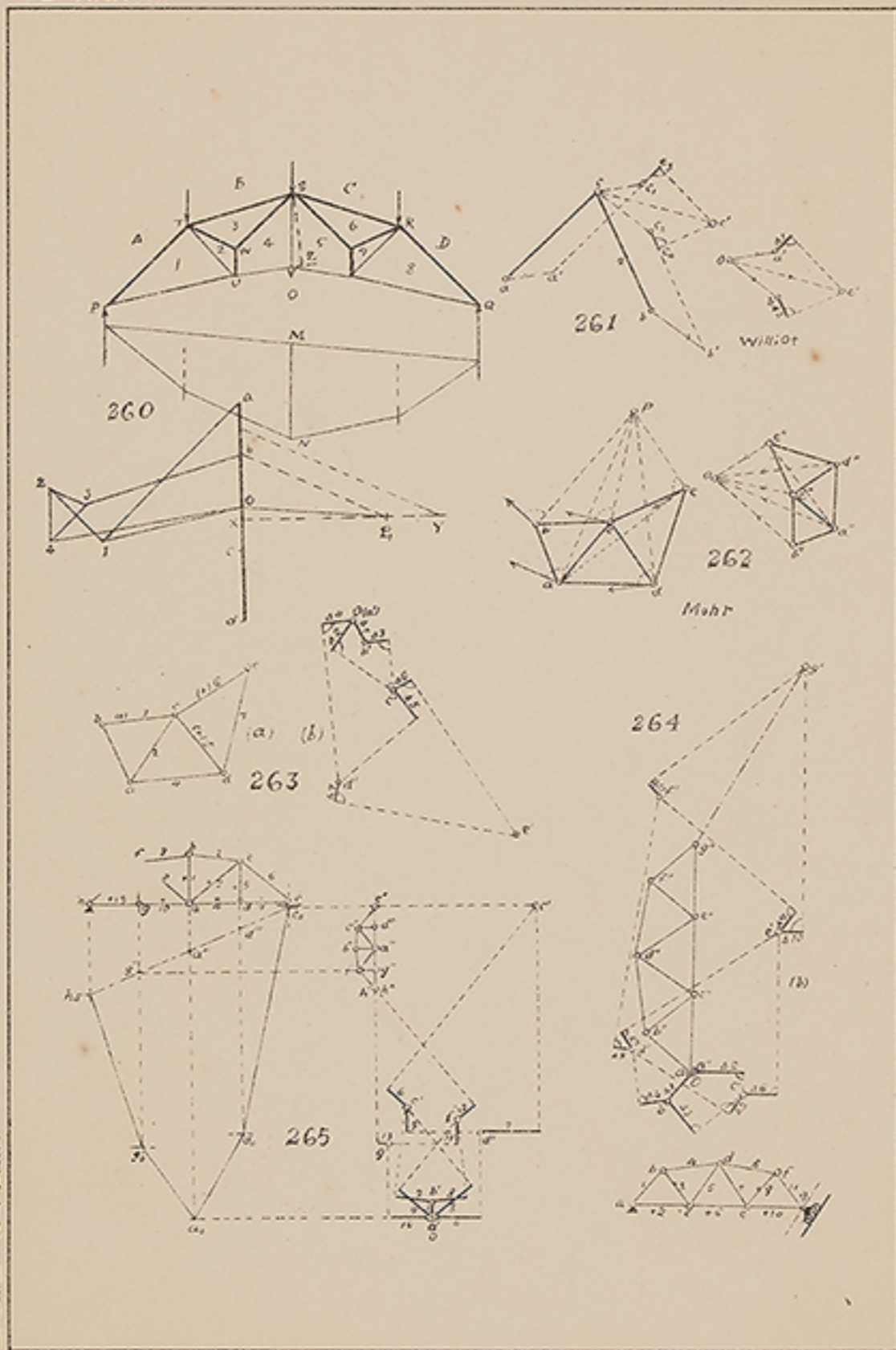

建築學會第一回講習用

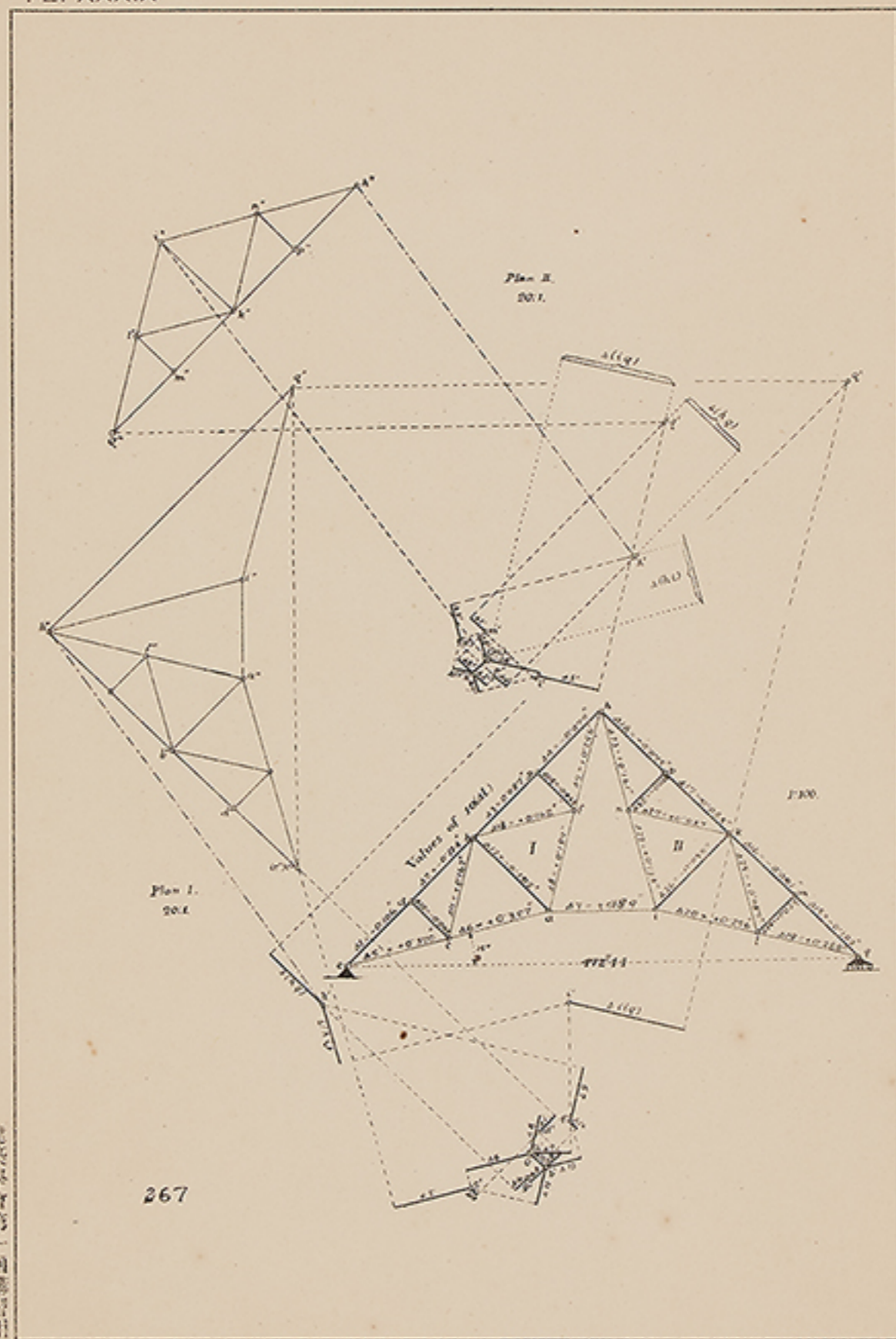

建築學會第一回講習用

267

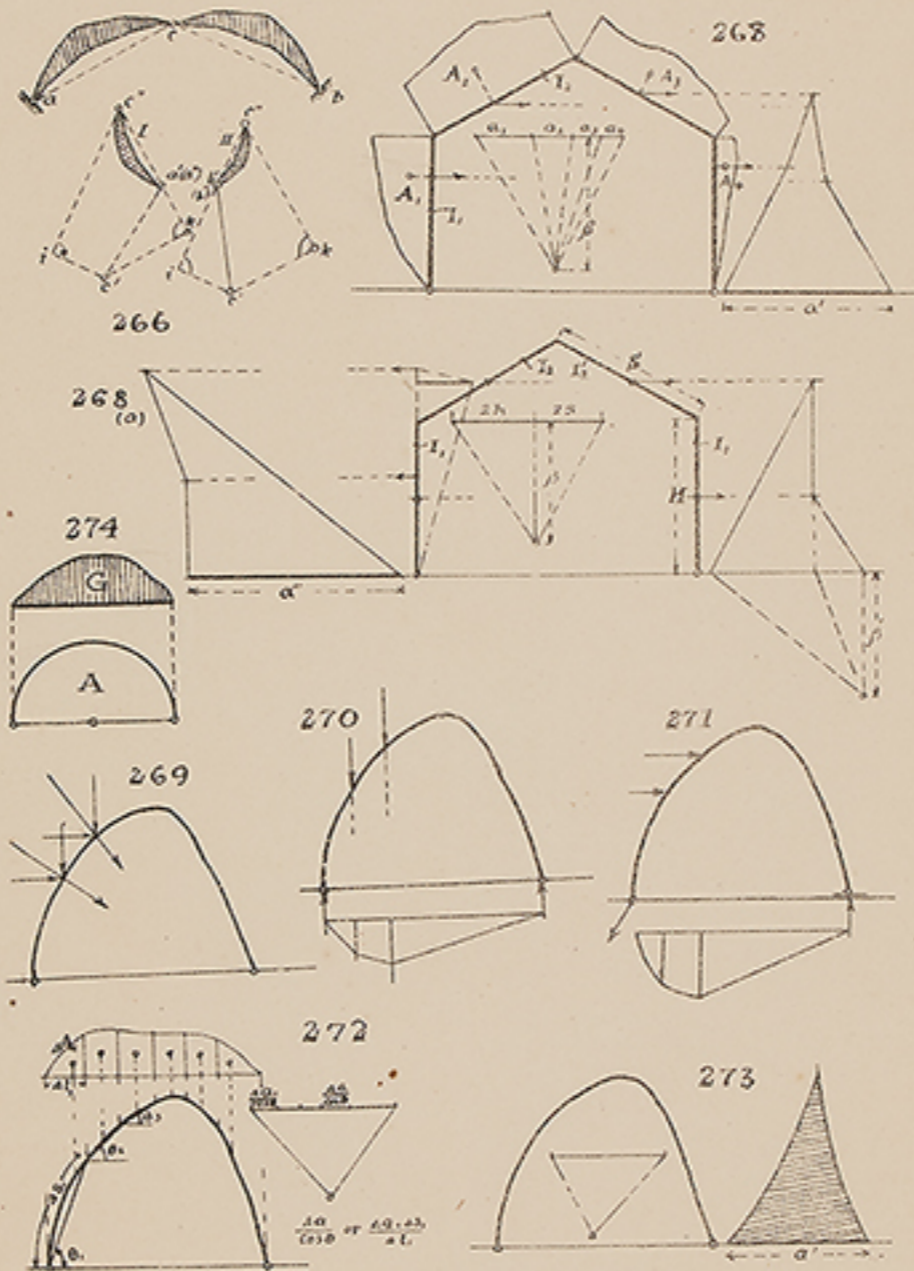

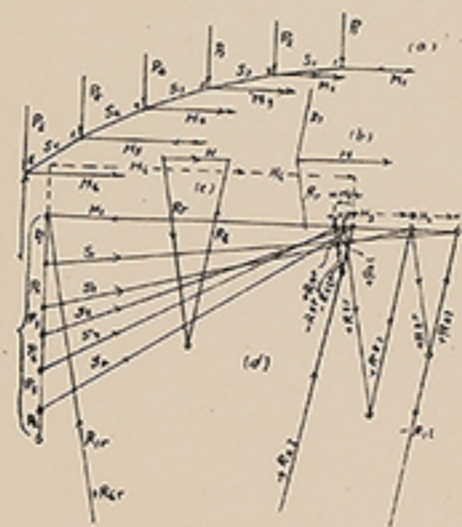
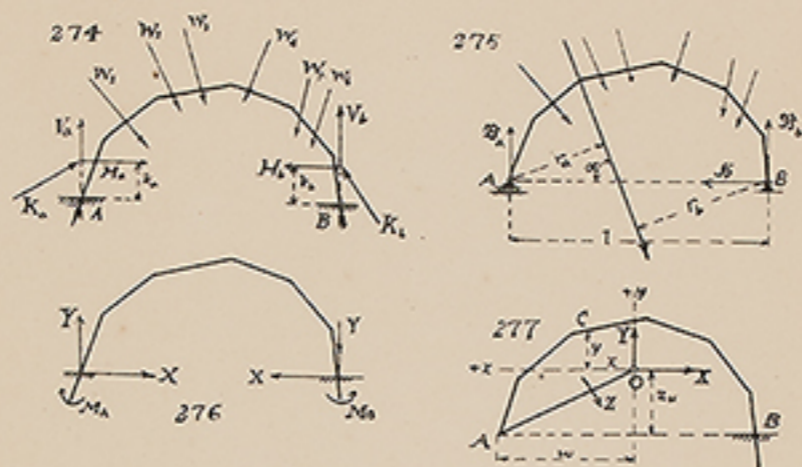

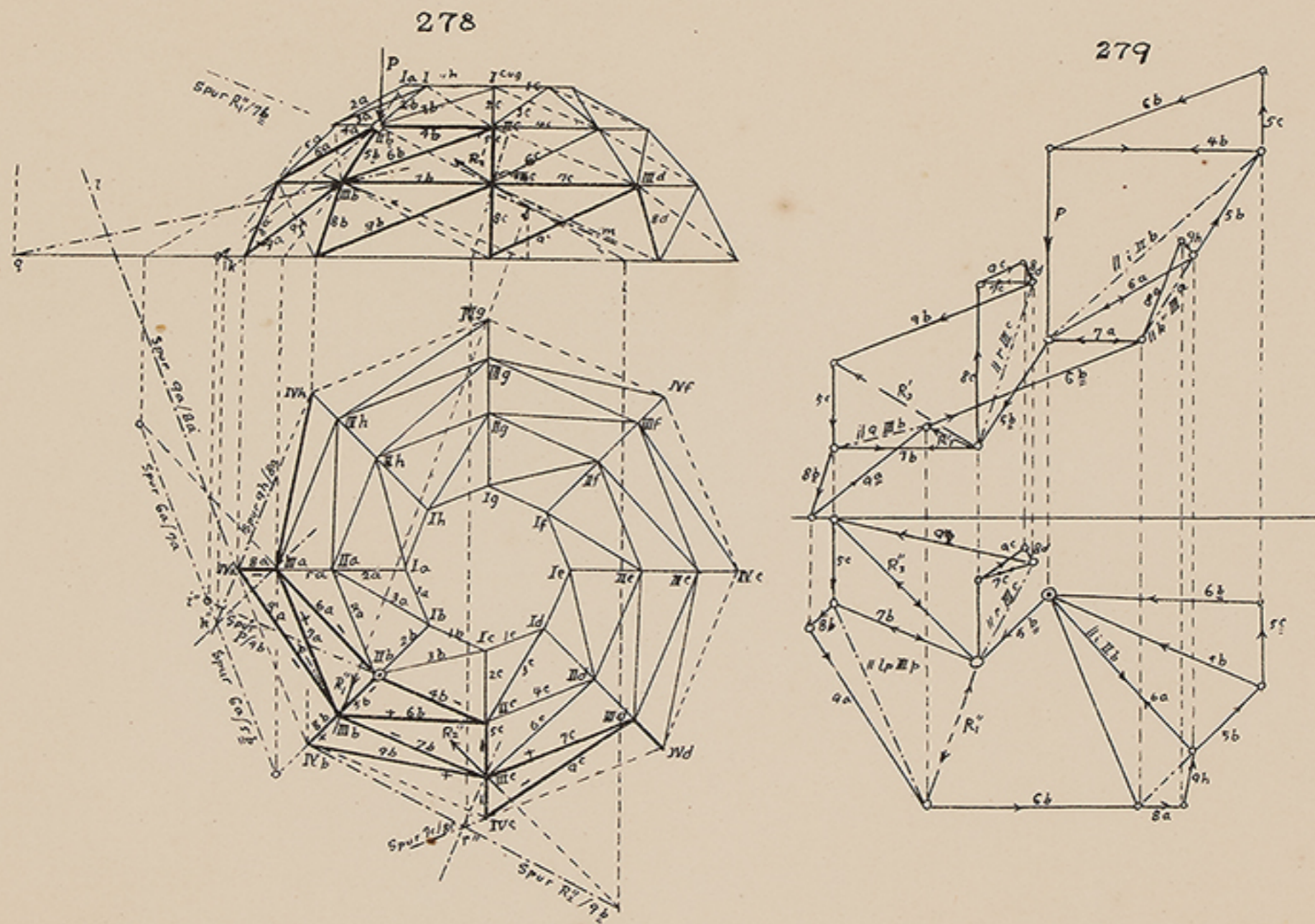

PL. XLIII



GROSSVIE MARKTHALLE, KOBLENZ.

建築学会第一回講習會用

PL. XLIV



Jubiläumshalle in Breslau

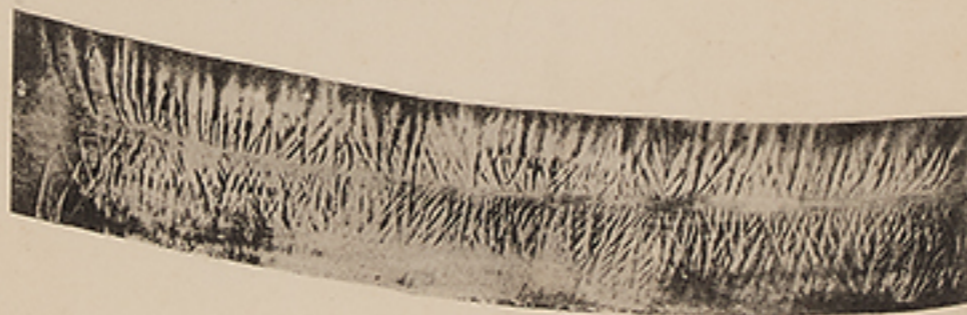

建築學會第一回講習會用